



This is a digital copy of a book that was preserved for generations on library shelves before it was carefully scanned by Google as part of a project to make the world's books discoverable online.

It has survived long enough for the copyright to expire and the book to enter the public domain. A public domain book is one that was never subject to copyright or whose legal copyright term has expired. Whether a book is in the public domain may vary country to country. Public domain books are our gateways to the past, representing a wealth of history, culture and knowledge that's often difficult to discover.

Marks, notations and other marginalia present in the original volume will appear in this file - a reminder of this book's long journey from the publisher to a library and finally to you.

### **Usage guidelines**

Google is proud to partner with libraries to digitize public domain materials and make them widely accessible. Public domain books belong to the public and we are merely their custodians. Nevertheless, this work is expensive, so in order to keep providing this resource, we have taken steps to prevent abuse by commercial parties, including placing technical restrictions on automated querying.

We also ask that you:

- + *Make non-commercial use of the files* We designed Google Book Search for use by individuals, and we request that you use these files for personal, non-commercial purposes.
- + *Refrain from automated querying* Do not send automated queries of any sort to Google's system: If you are conducting research on machine translation, optical character recognition or other areas where access to a large amount of text is helpful, please contact us. We encourage the use of public domain materials for these purposes and may be able to help.
- + *Maintain attribution* The Google "watermark" you see on each file is essential for informing people about this project and helping them find additional materials through Google Book Search. Please do not remove it.
- + *Keep it legal* Whatever your use, remember that you are responsible for ensuring that what you are doing is legal. Do not assume that just because we believe a book is in the public domain for users in the United States, that the work is also in the public domain for users in other countries. Whether a book is still in copyright varies from country to country, and we can't offer guidance on whether any specific use of any specific book is allowed. Please do not assume that a book's appearance in Google Book Search means it can be used in any manner anywhere in the world. Copyright infringement liability can be quite severe.

### **About Google Book Search**

Google's mission is to organize the world's information and to make it universally accessible and useful. Google Book Search helps readers discover the world's books while helping authors and publishers reach new audiences. You can search through the full text of this book on the web at <http://books.google.com/>



B 5940.52

B



Harvard College Library

FROM

Robert Hoe





# A Short History of The Printing Press

And of the Improvements in  
Printing Machinery from the  
Time of Gutenberg up  
to the Present Day



FROM A MEDAL BY SCHARFF OF VIENNA

PRINTED AND PUBLISHED FOR  
ROBERT HOE  
NEW YORK

1902



A Short History of  
**The Printing Press**

---





5

# A Short History of The Printing Press

And of the Improvements in  
Printing Machinery from the  
Time of Gutenberg up  
to the Present Day

*How to use it*



FROM A MEDAL BY SCHARFF OF VIENNA

PRINTED AND PUBLISHED FOR  
ROBERT HOE  
NEW YORK  
1902

II. 6235  
12  
B

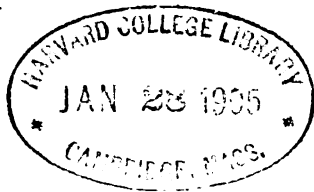

Handwritten text, possibly a signature or date, located below the stamp.

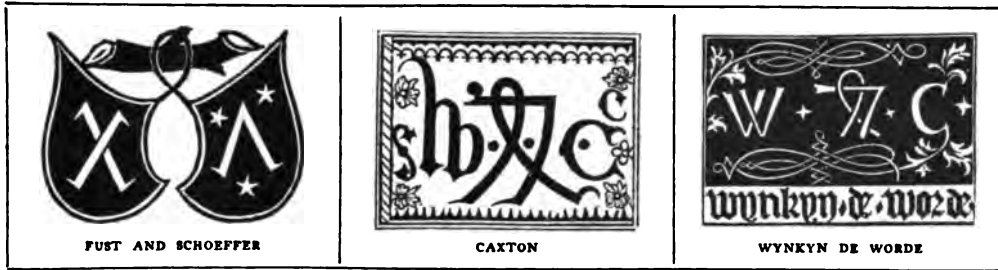

## THE PRINTING PRESS

**A**BOUT the year 1450, Gutenberg was engaged in printing his first book from movable types. No method of taking the impressions simpler than that employed by him can be imagined, unless it be with a “buffer,” or by means of a brush rubbed over the paper laid upon the “form” of type, after the manner of the Chinese in printing from engraved blocks. His printing press consisted of two upright timbers, with cross pieces of wood to stay them together at the top and bottom. There were also intermediate cross timbers, one of which supported the flat “bed” upon which the type was placed, and through another a wooden screw passed, its lower point resting on the centre of a wooden “platen,” which was thus screwed down upon the type. After inking the form with a ball of leather stuffed with wool, the printer spread the paper over it, laying a piece of blanket upon the paper to soften the impression of the platen and remove inequalities. This was the machine which Gutenberg used. The mechanical principle embodied in it was found in the old cheese and linen presses ordinarily seen in the houses of medieval times.

Were Gutenberg called upon to print his Bible to-day he would find virtually the same type ready for his purpose as that

## THE EARLIEST FORM OF PRINTING PRESS



THE EARLIEST FORM OF PRINTING PRESS

made by him, no change having taken place in its general conformation; but he would be bewildered in the maze of printing machinery of the beginning of the twentieth century.

The simple form of wooden press, worked with a screw by means of a movable bar, continued in use for about one hundred and fifty years, or until the early part of the seventeenth century, without any material change. The forms of type were placed upon the same wooden and some-

times stone beds, incased in frames called "coffins," moved in and out laboriously by hand, and after each impression the platen had to be screwed up with the bar so that the paper which had been printed upon it might be removed and hung up to dry.

The first recorded improvements in this press were made by William Jensen Blaew, a printer of Amsterdam, some time about 1620. They consisted in passing the spindle of the screw through a square block which was guided in the wooden frame, and from this block the platen was suspended by wires or cords; the block, or box, preventing any twist in the platen, and insuring a more equal motion to the screw. He also placed a device upon the press for rolling in and out the bed, and added a new form of iron hand lever for turning the screw. Blaew's press was introduced into England, and used there as well as on the continent, being substantially the

## THE BLAEW PRESS

same as that Benjamin Franklin worked upon as a journeyman in London, early in the last century.

Little further improvement was made in the printing press before the year 1798, when the Earl of Stanhope caused one to be made, the frame of which, instead of being of wood, was one piece of cast-iron. A necessity had arisen for greater power in giving the impression, especially in the printing of woodcuts, and the tendency was naturally toward larger forms of type, requiring greater



THE BLAEW PRESS

exertion on the part of the printer; the labor in working one of the old screw presses was about equal to that of the plowman in the field. The Earl of Stanhope reserved the screw, but caused to be added a combination of levers to assist the pressman in gaining greater power, when giving the impression, with less expenditure of energy. These machines were very heavy and extremely cumbersome. They were the first iron printing presses ever constructed, and came into use to some extent. The printers, seizing upon this new idea of a combination of levers to increase the power, were induced to place them upon their wooden presses, the improvement resulting generally in the destruction of the latter, which were not adapted to stand the strain. The iron platen employed by the Earl of Stanhope had, however, previously been used upon the wooden presses.

## STANHOPE PRESS

The next practical improvement was made by George Clymer of Philadelphia, who, about 1816, devised an iron machine, entirely dispensing with a screw. A long, heavy cast-iron lever was placed over the platen, one end attached to one of the uprights of the cast-iron frame, and the other susceptible of being raised and lowered

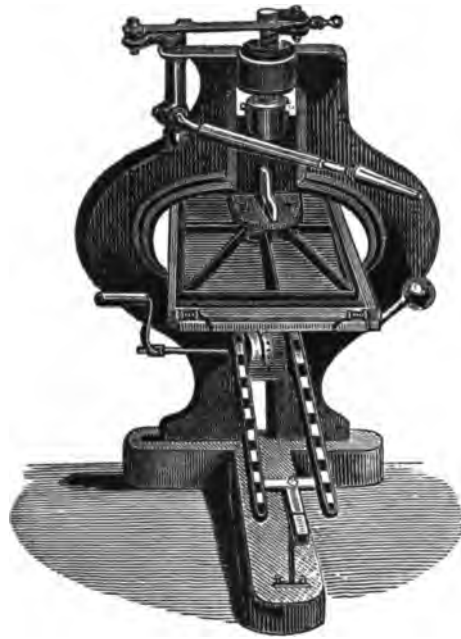

STANHOPE PRESS

by a combination of smaller levers, worked by the pressman after the manner of the ordinary hand press. The impression was given and the platen raised and lowered by a spindle, or pin, attached to the centre of the large cross lever at the top, this being properly balanced to facilitate its being raised with greater ease. Mr. Clymer carried his invention to England, where it was introduced to some extent and was known as the "Columbian" press.

In England there were iron hand presses made by Rutheven, by Brown and by others, all, more

or less, improvements upon the Stanhope.

In 1822 Peter Smith, an American, connected with the firm of R. Hoe & Co. in New York, devised a machine which was in many respects superior to any up to that time. The frame was of cast-iron, and in place of the screw with levers, he substituted a toggle joint, at once simple and effective.

In 1827, however, Samuel Rust of New York, perfected an invention which was a great improvement on the Smith press. The frame, instead of being all of cast-iron, had the uprights at the sides hollowed for the admission of wrought-iron bars, which were

## CLYMER'S COLUMBIAN PRESS

securely riveted at the top and bottom of the casting. This gave not only additional strength, but greatly diminished the amount of metal used in construction. This patent was purchased by R. Hoe & Co., who improved upon it, and proceeded with the manufacture of the presses, although the "Smith" continued to be used to some extent. The new invention was known as the "Washington" press, and in principle and construction has never been surpassed by any hand printing machine. They were manufactured in great numbers, and continue to be manufactured and sold at the present time for taking fine proofs, although the universal adoption of the cylinder press has almost entirely superseded them for other printing. The number made and sold by Hoe & Co. alone, a majority of which are now in use, is over six thousand. They have been sent all over the world. This style of press is made in seven sizes.

The following is a description of this press : The bed slides on

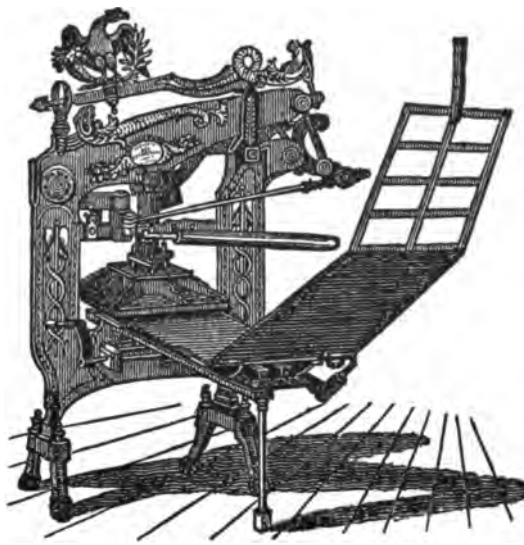

CLYMER'S COLUMBIAN PRESS



PETER SMITH HAND PRESS



## WASHINGTON HAND PRESS



WASHINGTON HAND PRESS

a track and is run in and out from under the platen by turning a crank which has belts attached to a pulley upon its shaft. The impression of the platen is given by means of a curved lever acting on a toggle joint, and the platen is lifted by springs on either side.

Attached to the bed is a "tympan" frame covered with cloth, and standing inclined, to receive the sheet to be printed. Another frame, called the "frisket," is attached to the tympan, and covered with a sheet of paper, having the parts which otherwise would be

printed upon cut away, so as to prevent the "chase" and "furniture" from blacking or soiling the sheet. The frisket is turned down over the sheet and tympan and all are folded down when the impression is taken. Automatic inking rollers were attached to this machine, operated by a weight raised by the pull of the pressman, the descent of the weight drawing the rollers over the type and returning them to the inking cylinder while the pressman placed another sheet upon the tympan. Still further improvements in this inking apparatus were made and patented by Hoe & Co., in which the distribution of the ink on the rollers was effected by means of an apparatus driven by steam power and which also caused the inking rollers to move forward over the type at the will of the pressman.

The bed and platen system of printing was, up to the middle of the nineteenth century, the favorite method of printing fine books and cuts. The first "power" or steam press upon this prin-

## TREADWELL'S PLATEN POWER PRESS

ciple was made by Daniel Treadwell; of Boston, in 1822. The frames were of wood, and it does not appear that more than three or four of these were ever constructed. The best machines of this description were those devised and patented by Isaac Adams, of Boston, in 1830 and 1836, and by Otis Tufts, of the same place, in 1834.

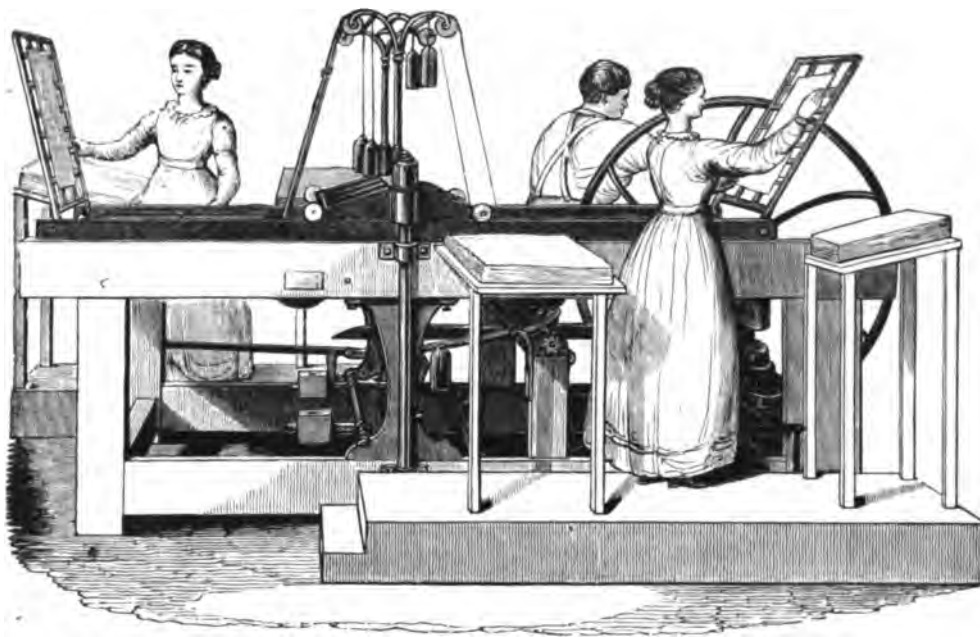

TREADWELL'S WOODEN-FRAME BED AND PLATEN POWER PRESS

They were first made with wooden and afterward with iron frames. In 1858 Adams's business became the property of Hoe & Co., who continued to manufacture the machines with added improvements. In all more than a thousand, in no less than fifty-seven sizes, were sold for use in the United States, some being sent to other countries. In these machines, the type is placed upon an iron bed, after the usual manner of the hand press, and this bed is raised and lowered by straightening and bending a toggle joint by means of a cam,

## ISAAC ADAMS'S BED AND PLATEN PRESS

thus giving the impression upon the iron platen fixed above it, and firmly held in position by upright iron rods secured to the bottom bar, a strong cross-piece, at the base of the machine. The ink fountain is at one end of the press; the inking rollers travel twice over the form, in a movable frisket frame, while the bed is down; the paper is taken in by grippers on the frisket and carried over the form, when the bed rises and the impression is given; and finally the sheets pass forward from the frisket by tapes to a sheet flier, which delivers them on the fly board. One thousand sheets per hour is the maximum speed of the larger sizes of the Adams press. Although many of these machines were made and great numbers are still used, and notwithstanding the fact that it was thought by many experienced printers that fine book and cut work could be done in no other way than by flat pressure, this system of printing has given place to that of the cylinder press.

The idea of printing from plates or forms carried upon a flat bed beneath a cylinder was not a new one, having been employed by printers of copper-plate engravings in the fifteenth century. Their machines, however, were rude in form, and made of wood, the roller revolving in stationary bearings, while the bed, with the plate upon it and carrying the paper, covered by a blanket, on its surface, moved backward and forward under the roller. The inking was done by hand with balls. With the inauguration of this system of printing from type or forms placed upon a flat bed moved forwards and backwards under a revolving cylinder, commenced an entirely new era in the history of the printing press. It should be understood, however, that the vast number of patents granted for printing machines in which the cylinder is connected with the bed, or by the operation of two cylinders together, one holding the form and the other giving the impression, are almost all for improvements and devices of detail, the radical principles upon which these are founded remaining the same. Thus, Sir Rowland Hill, in the early

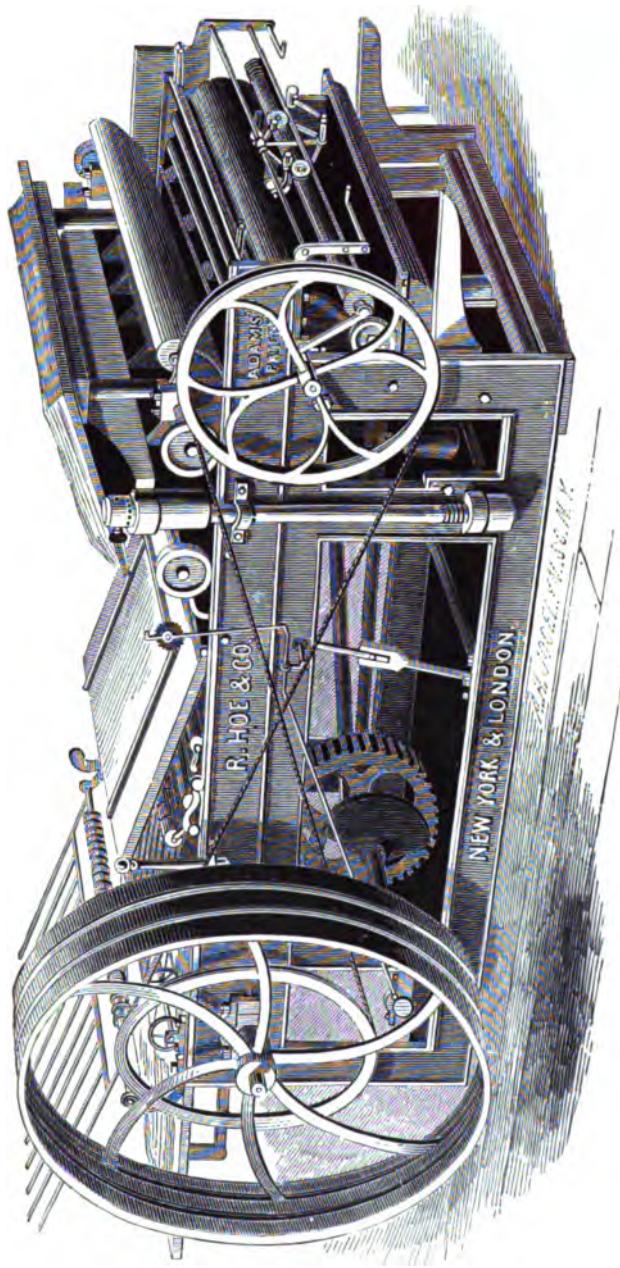

ISAAC ADAMS'S BED AND PLATEN PRESS



## THE FIRST CYLINDER PRESS

part of the nineteenth century, projected a machine for printing from an endless roll, or "web" of paper; and in 1790 an Englishman named William Nicholson (author, inventor, patent agent, editor and school teacher) took out a patent covering the idea of cylinder presses in which the forms should be placed upon either a flat bed or cylinder at will and receive the impression from a cylinder covered with cloth or some similar material. Between the bed and cylinder, or between the two cylinders, the sheet was to be fed in and printed. The ink was to be put on by a roller built up of cloth and covered with leather. There is, however, a great difference between an actual invention and a scheme. If the simple proposition advanced to make a machine upon this principle, without its consummation, or without any press being produced, can be considered an invention, then Nicholson may (as a writer on the subject states) have been "so far ahead of his time as to leap over three generations" by his invention. As a matter of fact, however, his patents were mostly schemes, and little more, as a moment's reflection will convince. He did not know how to curve the plates to be put upon the cylinders, nor how to secure them properly for good work—in fact, he did not know how to make the plates in any practicable manner. All these questions remained to be solved in order that the printing press might be an invention. On this account, therefore, I do not give descriptions of proposals to make machines, but of presses that have been actually made, and used sufficiently to entitle them to recognition as practical improvements exemplifying the progressive evolution of the printing press.

The foundation and growth of newspapers first published periodically, and finally each day, created a demand for machines which should print with rapidity, and fine work was delegated for the time being to the flat bed and platen press, most of it, as has been seen, being turned out upon the hand press.

The credit of actually introducing into use a flat bed Cylinder

## THE KOENIG CYLINDER PRESS

Press is due to a Saxon named Friederich Koenig, who visited England in 1806, and through the assistance of Thomas Bensley, a printer in London, devised a machine which in 1812-1813 was worked by him, and printed, among other publications, a part of "Clarkson's Life of William Penn." Koenig was assisted by a mechanic named Andrew Bauer, a fellow-countryman. The form of type was placed on a flat bed, the cylinder above it having a three-fold motion, or stopping three times; the first third of the turn receiving the sheet upon one of the tympan and securing it by the frisket; the second giving the impression and allowing the sheet to be removed by hand, and the third returning the tympan empty to receive another sheet.

These men also devised what has proved, even to this day, to be a most efficient reciprocating motion of the type bed. It consists of a pinion carried on the inner end of a long shaft which is turned by gearing from the outside of the press frame and has in its length a universal joint, allowing an up-and-down motion of the pinion as it revolves. To the outer end of the shaft the wheel connecting with the impression cylinder is attached. Underneath the bed and fastened to it is a "rack," or a row of teeth, with a crescent-shaped segment of hard metal at each end. In this rack, in addition to the teeth, are pins, or studs, at each end. The wheel before referred to, at the outer end of the shaft, being set in motion revolves the pinion and moves the bed by means of the teeth in this rack. At the proper moment, calling for the reversal of the bed, the pinion turns around over one of the pins or studs, against the segment on the rack, and immediately re-engages its teeth in the opposite side of the rack, so carrying the bed back again. This motion is repeated at the opposite end of the rack, and the bed again stopped and returned by the pinion revolving against the segment and again over the rack, thus giving a reciprocating motion to the bed.

In 1814 Koenig patented a continuously revolving Cylinder

## THE KOENIG CYLINDER PRESS

Press. The part of the periphery of the cylinder not used for giving the impression is slightly reduced in diameter, so as to allow the form to return under it freely after giving an impression. He showed designs adapting it for use as a single Cylinder Press, and also a two Cylinder Press, both for printing one side of the paper at a time; likewise a two Cylinder Press for printing both sides of the paper at one operation. In this later press, the two forms were placed one at each end of a long bed, and the paper after being printed on one side by one cylinder, was carried by tapes over a registering roller to the other cylinder, where it was printed upon the reverse side. This press, termed a "perfecting press," was afterwards improved by Applegath & Cowper so as to be a very efficient machine.

Koenig erected in the office of the London "Times" in 1814 two of the two Cylinder Presses mentioned above, which printed on one side of the paper only, at the rate of 800 sheets per hour.

Koenig, however, was not alone in his efforts to perfect a Cylinder Press. Various patents were gotten out by Bacon & Donkin in 1813; by Cowper in 1816 and again in 1818; and by Applegath in 1818. But the most ingenious and practical device in connection with the movements of a flat bed and a cylinder for printing machines was patented by Napier in 1828 and 1830. He was the first who introduced "grippers," or "fingers," for the conveyance of the sheets around the cylinder during the impression, and for delivering them after printing. Tapes or strings had previously been employed for this purpose. He was also the first to manufacture presses in which the impression cylinders are of small size and make two or more revolutions to each sheet printed, and he devised the toggles for bringing the cylinders down to print on the form and for raising them to let the form run back without touching.

The news of these later inventions reached New York in due time, and in 1832 Robert Hoe, who had been some time established



## SINGLE SMALL CYLINDER PRESS

in the manufacture of printing presses, sent a young man, Sereno Newton (whom he afterwards took in partnership with him), to

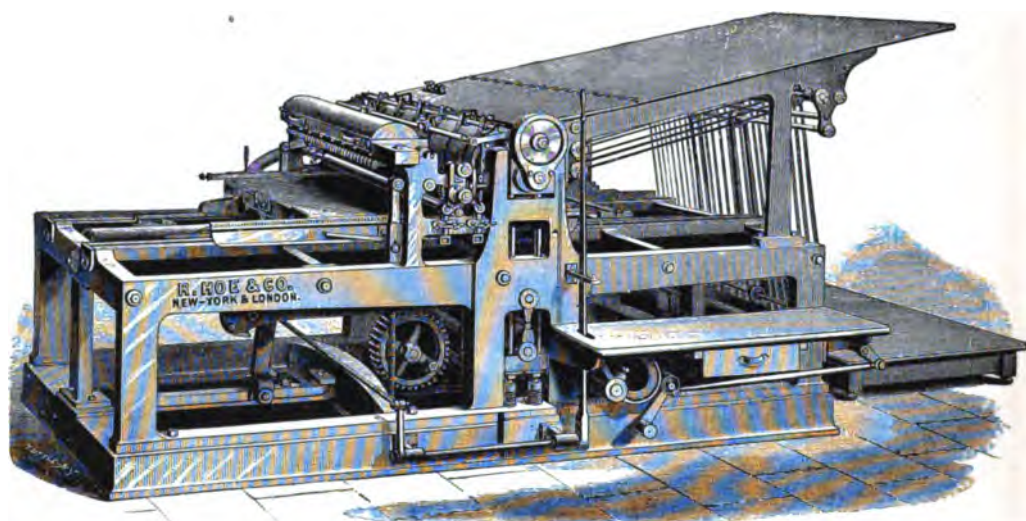

SINGLE SMALL CYLINDER PRESS

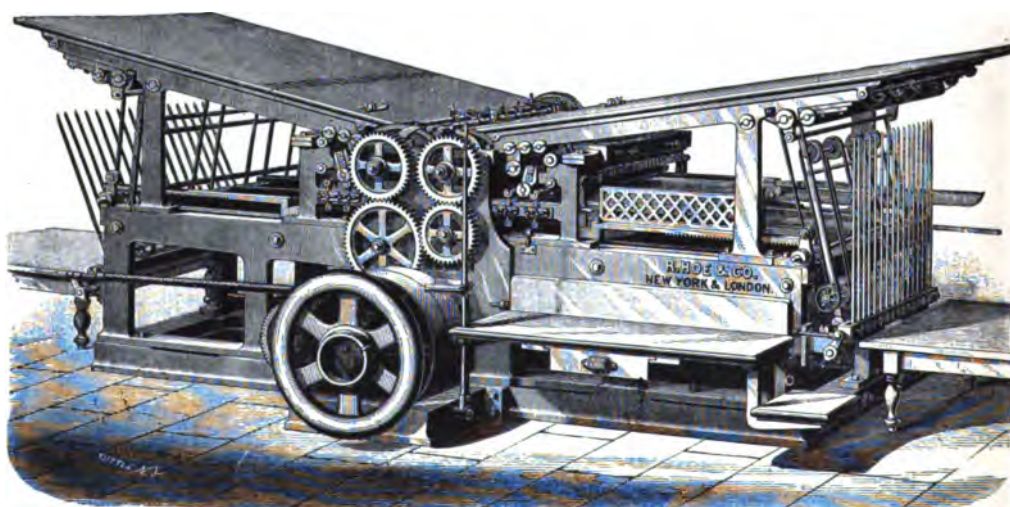

DOUBLE CYLINDER PRESS

England to investigate the subject and see what improvements were worthy of adoption. The result was the construction of the

## SINGLE LARGE CYLINDER PRESS

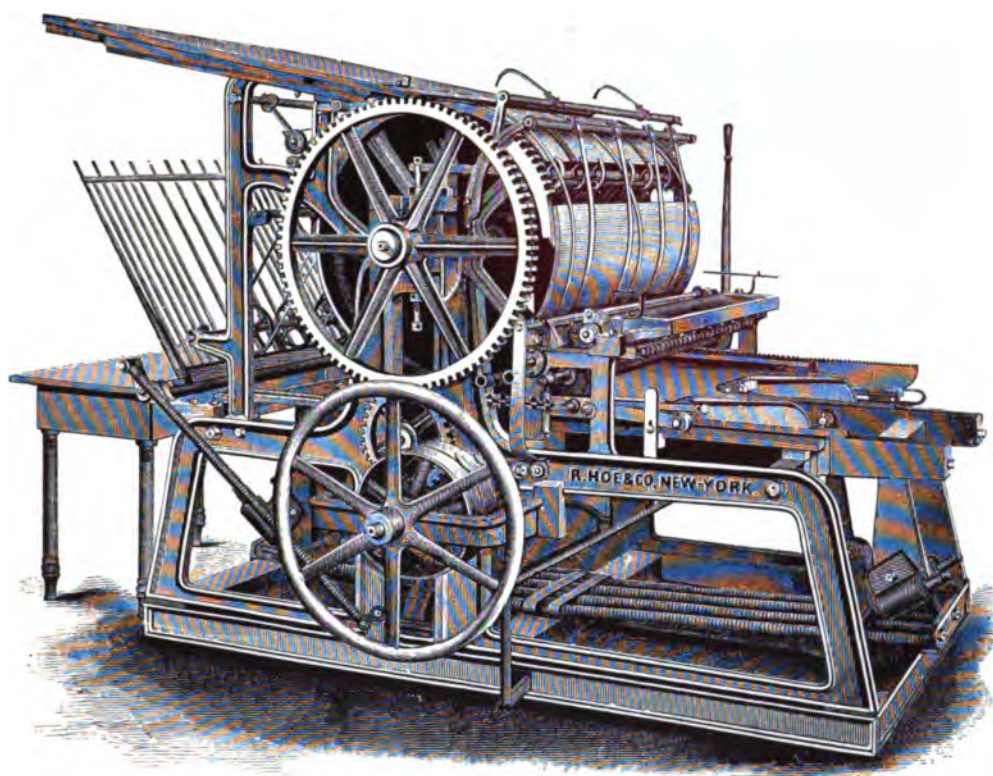

W. ROBERTS SC. N. Y.

SINGLE LARGE CYLINDER PRESS

machines known as the "Single Small Cylinder" and "Double Small Cylinder," also the large Cylinder "Perfecting" Press, which have continued, with many alterations and improvements, to be manufactured up to the present time.

Hoe & Co. had previously made the first flat bed and cylinder press ever used in the United States. It was the pattern known as the "Single Large Cylinder," the whole circumference of the cylinder being equivalent to the entire travel of the bed forwards and backwards, the cylinder making one revolution for each impression in printing, without stopping. Only a portion of the cylinder was employed to take the impression, the remainder of its circumference being

## SINGLE LARGE CYLINDER PRESS

turned down small enough to allow the type on the bed to pass back under it without touching. Hundreds of these machines were made and are now in use, and they are still made at the present day, with patented sheet fliers and other devices and improvements in the methods of manufacture. Other similar presses were made later by the press-makers A. B. Taylor, A. Campbell, C. B. Cottrell, and C. Potter, Jr.

The patented sheet flier before referred to, and which was used on the "Adams" bed and platen press, was greatly improved by Hoe & Co. and placed upon all their cylinder presses.

Before proceeding further with an account of the faster newspaper presses, it may be well to complete the history of machines employed up to this time for book, job and woodcut printing. For this purpose the "Single Large Cylinder," already described, was first used. In England there were the "Napier" presses, the "Wharfedale" and many others, all involving the same general principle, and capable of turning out more or less satisfactory work, in proportion to the perfection of their construction and the skill of those operating them. Most of the English machines, however, show defects in mechanical construction. In fact, the supremacy of the American printing press is maintained in a large measure by the simplicity, accuracy and perfection of its mechanism. Foreign presses, made by the cheap labor of Europe, have been repeatedly brought to this country and introduced into printing offices. They have never, however, lasted long, most of them having perished in the using or been found unprofitable.

There have been various modifications of the principle underlying the Napier movement for flat-bed presses, i. e., having the driving wheel engage the rack at all times, reversing the movement by turning about the ends of the rack and driving the bed alternately in opposite directions.

As early as 1847 Hoe & Co. patented an entirely new bed

## THE MIEHLE PRESS

driving mechanism. To a hanger fixed on the lower side of the bed were attached two racks facing each other, but not in the same vertical plane, and separated by a distance equal to the diameter of the driving wheel, which was on a horizontal shaft and movable sideways so as to engage in either one or other of the racks. By this means, a uniform movement was obtained in each direction.

The reversal of the bed was accomplished by a roller at either end of the bed entering a recess in a disc on the driving shaft, which in a half revolution brought the bed to a stop and started it in the opposite direction.

This involved a new principle; a crank action operating directly upon the bed from a shaft having a fixed centre, and within recent years modifications of this patent have been successfully employed to drive the type bed at a high velocity and reverse it without shock or vibration.

The "Miehle" Press is a modified form of this movement; the crank pin or roller is attached to the side of the bed wheel, and at the ends of the uniform movement it is enclosed within the walls of a vertical guideway formed at each end of the rack supporting frame, and passes through the length of this guide as it performs its function of reversing the bed.

An improvement in this class of bed motions has lately been made and patented by Hoe & Co. In this machine the crank pin, which controls the reversal of the motion of the type bed, moves in a rectilinear instead of a circular pathway. As the motion of the crank is thus directly in line with the travel of the bed, it is possible to lock the journal box, enclosing the pin, securely to the bed, while the bed is being controlled by the action of the crank, and thereby avoids the friction and consequent wear of parts that occur when the crank pin moves in a circular line. The movement of the crank is obtained from the rotatory motion of the bed wheel, and has the same varying velocities as would be derived from a crank

## STOP CYLINDER LITHOGRAPHIC PRESS

traveling in a circular pathway. It, therefore, checks the momentum of the bed with ease, brings the bed to rest, and returns it with an accelerating motion while under positive control. The wearing of parts is thus reduced to the minimum, insuring an accuracy of register and exactness of motion hitherto unattainable. A press with a bed measuring 48 x 65 inches runs without jar or vibration at a speed of 1,800 impressions an hour.

The press of the present day from which the finest letterpress and woodcut work is turned off is known as the "Stop Cylinder." This was devised and patented by a Frenchman named Dutartre, in 1852, and introduced into this country about 1853 by Hoe & Co., who have since patented many improvements upon it. It was a surprise to many printers to find that this machine could do work which heretofore it had been supposed the hand press only was capable of performing.

The Stop Cylinder Press may be described as follows: The type is secured upon a traveling iron bed, which moves back and forth upon friction rollers of steel, the bed being driven by a simple crank motion, stopping and starting it without noise or jar. All the running portions of this bed are made of fine steel as hard as it can be worked. The cylinder is stopped by a cam motion pending the backward travel of the bed, and during the interval of rest the sheet is fed down against the guides and the grippers closed upon it before the cylinder starts, thus insuring the utmost accuracy of register. After the impression, the sheet is transferred to a skeleton cylinder, also containing grippers, which receives, and delivers it, over fine cords, upon the sheet flier, which in turn deposits it upon the table. The distribution of the ink is effected partly by a vibrating, polished, steel cylinder, and partly upon a flat table at the end of the traveling bed, the number of form-inking rollers varying from four to six. This is without doubt the most perfect flat bed cylinder printing machine that has ever been

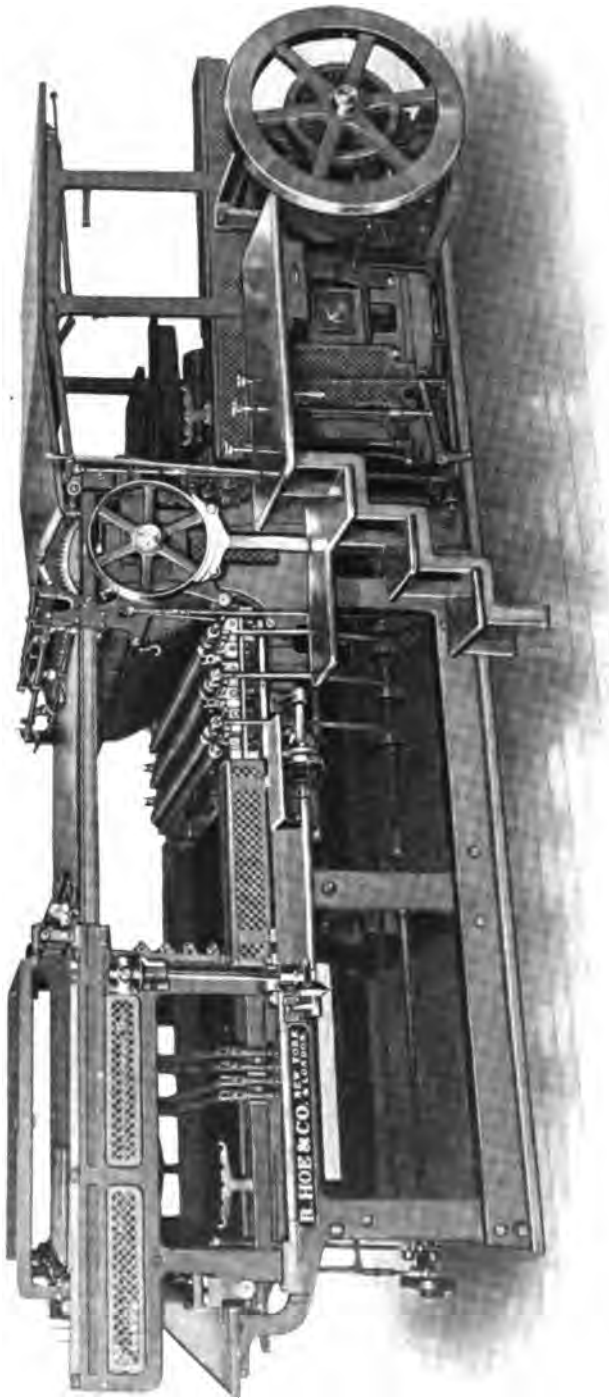

STOP CYLINDER LITHOGRAPHIC PRESS



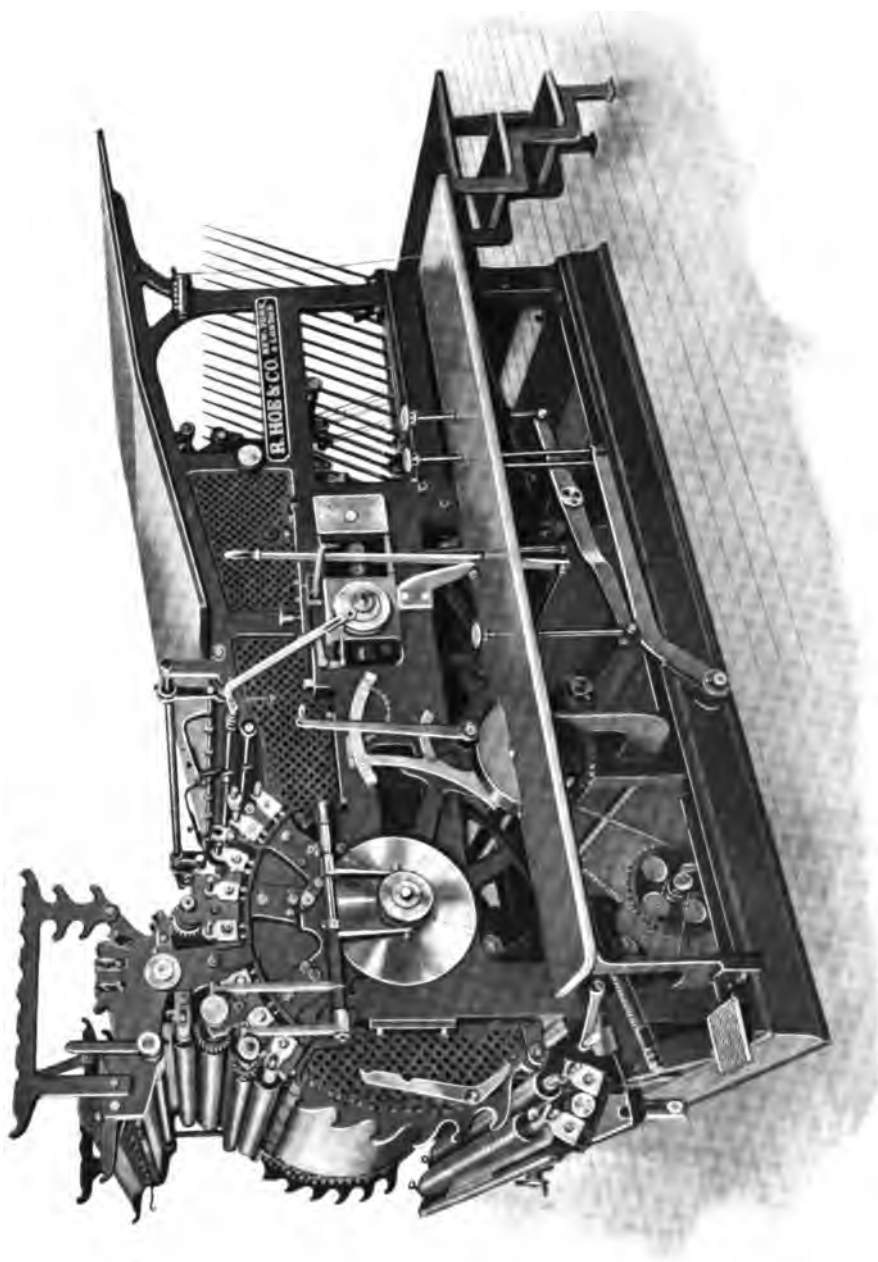

ROTARY ZINCOGRAPHIC OR ALUMINUM PRESS





## ROTARY ZINCOGRAPHIC PRESS

devised. It is made in various sizes. The average output of one of these presses with a bed 36 x 54 inches is from 1,000 to 1,500 impressions per hour.

The demand being constantly for machines taking on larger sized forms, there has been lately constructed and patented by R. Hoe & Co. an entirely new Stop Cylinder Press, having a bed 45 x 62 inches, and which can be run at a speed of 1,700 impressions an hour. The main points of difference between the Stop Cylinder Press for type forms and the Lithographic Press is in the form of the bed only, the other portions, including the driving apparatus, being almost identical; therefore the same general description applies to these new machines for both classes of work. A great objection to flat-bed presses of large size has always been the height of the cylinder from the floor, necessitated by the increased dimensions of the driving apparatus under the bed. In these new presses the bed is reciprocated as usual by a crank motion, but made exceptionally strong and compounded. This method of construction not only gives the increased speed but makes the bed of the machine low down, so that it is better under the hand and eye of the operator. The product of the machine is delivered printed side up, by a patented take-off apparatus, which takes the sheets from the impression cylinder by grippers in a reciprocating carriage and deposits them upon a table. No tapes or guides come in contact with the freshly printed ink.

Keeping pace with the improved methods and machines employed in typographic printing, and influenced thereby, the lithographic and kindred branches of printing have also made progress, induced mainly, however, by the general striving for more rapid and economical production. This has been accomplished by using larger stones, paper and machines, and by employing rotary machines for some work. The use of curved stones for lithography being impracticable for many reasons, a substitute was found in

## TWO-COLOR ROTARY PRESSES

plates or sheets made of zinc or aluminum, which, when properly prepared, possess properties akin to those in lithographic stones. Being flexible, these sheets are easily stretched over the curved surface of a cylinder. Although the development of this branch of printing is due, chiefly, to the French and Germans, much has been done in this country toward its improvement, and work is produced upon Rotary Zincographic or Aluminum Presses that compares favorably with that produced from stones, and at double the speed. The smaller of these presses, printing only one color at a time, prints on sheets 30 x 44 inches, at a speed up to 2,000 impressions per hour; the larger presses of the same kind print on sheets 44 x 64 inches, at a speed up to 1,700 impressions per hour, although the machines may be run even faster, according to the dexterity of the feeder.

Two-Color Rotary Presses are in successful operation in different parts of this country. In these machines there are two plate cylinders and one impression cylinder, each of the plate cylinders having its own inking and dampening appliances. The sheet of paper, after being fed to the grippers of the impression cylinder, receives one printing from the first plate cylinder, and a second printing, in a different color, from the second plate cylinder, and is then released from the grippers and delivered in the usual manner by the sheet flier. The size of the sheets printed is 44 x 64 inches, and running at a speed of 1,700 revolutions per hour, the number of printings is 3,400, or double that obtained from the one-color machine of the same size.

We now return to a further consideration of the newspaper press. The "Single Small Cylinder" and "Double Small Cylinder" machines heretofore described as primarily the invention of Napier, and perfected by Hoe & Co. and made by them, came into general use in the United States. In construction and for the quantity and quality of work produced they excelled any made in England; the

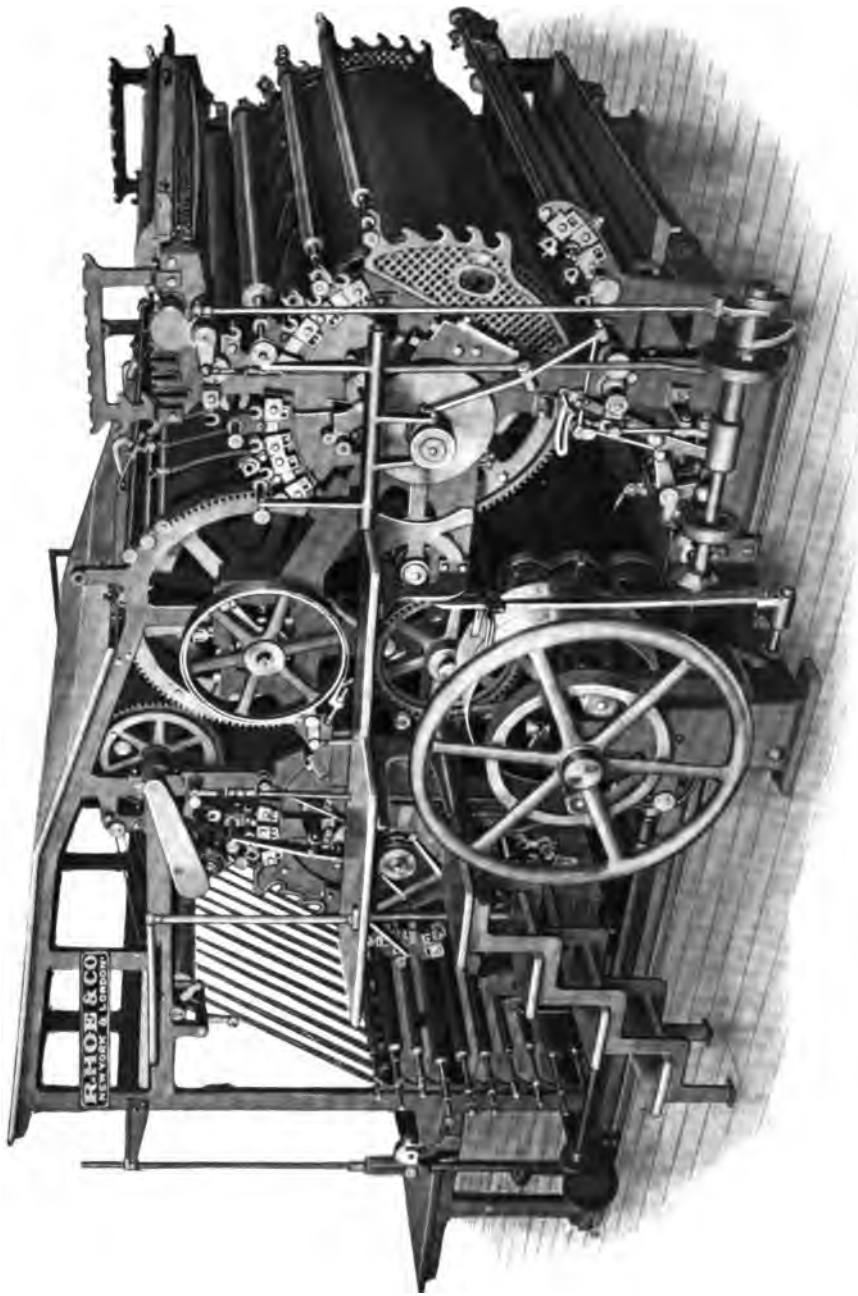

TWO-COLOR ROTARY ZINCOGRAPHIC OR ALUMINUM PRESS



## ROTARY TYPE-REVOLVING PRESS

output of one of the "Single Cylinder" presses reaching 2,000 impressions per hour, or about as fast as the feeder could lay down the sheets. When still greater speed was required the "Double Cylinder" press was used, the travel of the bed being of such length that the form of type passed backward and forward under both cylinders. Two feeders accordingly put in the sheets; the maximum speed obtained being about 2,000 from each cylinder, or 4,000 from the two cylinders per hour, printed on one side. It was evident, both in England and America, that something faster must be devised. The growing demand for papers containing the latest news necessitated increasing effort on the part of the machine-makers. The presses of Dryden & Ford, Middleton, and others in England failed to meet the requirements there, as did the "Single" and "Double" Cylinders in America.

In 1845 and 1846 the firm of R. Hoe & Co. in New York were busily engaged upon plans and inventions for presses which should meet the increased requirements of the newspapers in America. The result was the construction of a press known as the "Hoe Type Revolving Machine," embodying patents taken out by Richard M. Hoe. The first one of these machines was placed in the "Ledger" office in Philadelphia, in 1846. The basis of these inventions consisted in an apparatus for securely fastening the forms of type on a central cylinder placed in a *horizontal* position. This was accomplished by the construction of cast-iron beds, one for each page of the newspaper. The column rules were made "V" shaped; i. e., tapering toward the feet of the type. It was found that, with proper arrangement for locking up or securing the type upon these beds, it could be held firmly in position, the surface form a true circle, and the cylinder revolved at any speed required without danger of the type falling out. Around this central cylinder from four to ten impression cylinders, according to the output required, were grouped. The sheets were fed in by boys, and taken from the feed board

## ROTARY TYPE-REVOLVING PRESS

by automatic grippers, or fingers, operated by cams in the impression cylinders, and which conveyed them around against the revolving form of the central cylinder. Here again a great advantage was gained by the use of the patented sheet flier, consisting of a row of long wooden fingers fastened to the shaft, and operated by a cam and springs; the sheet after printing being conducted out underneath each feed board by means of tapes to the sheet fliers, which laid them in piles on tables; the number of fliers and tables corresponding to the number of impression cylinders. The inking was accomplished by the use of composition rollers placed between each of the impression cylinders; the fountain being below, underneath the main type cylinder. The portion of the surface of this type cylinder, not occupied by the type itself, was utilized as a distributing table, its surface being lower than that of the type, and the inking rollers rising and falling alternately to place the ink on the type and receive a new supply from the distributing surface. The first of these presses had only four impression cylinders, necessitating four boys to feed the sheets. The running speed obtained was about 2,000 sheets to each feeder per hour, thus giving, with what was called a "Four Feeder" or "Four Cylinder" machine, a running capacity of about 8,000 papers, per hour, printed upon one side. As the demands of the newspapers increased, more impression cylinders were added, until these machines were made with as many as ten grouped around the central cylinder, giving an aggregate speed of about 20,000 papers per hour printed upon one side. A revolution in newspaper printing took place. Journals which before had been limited in their circulation by their inability to furnish the papers rapidly increased their issues, and many new ones were started. The new presses were adopted not only throughout the United States, but also in Great Britain. The first one put up abroad was erected in 1848, in the office of "La Patrie" in Paris, but the downfall of the Republic and the re-imposition of a stamp duty, soon put

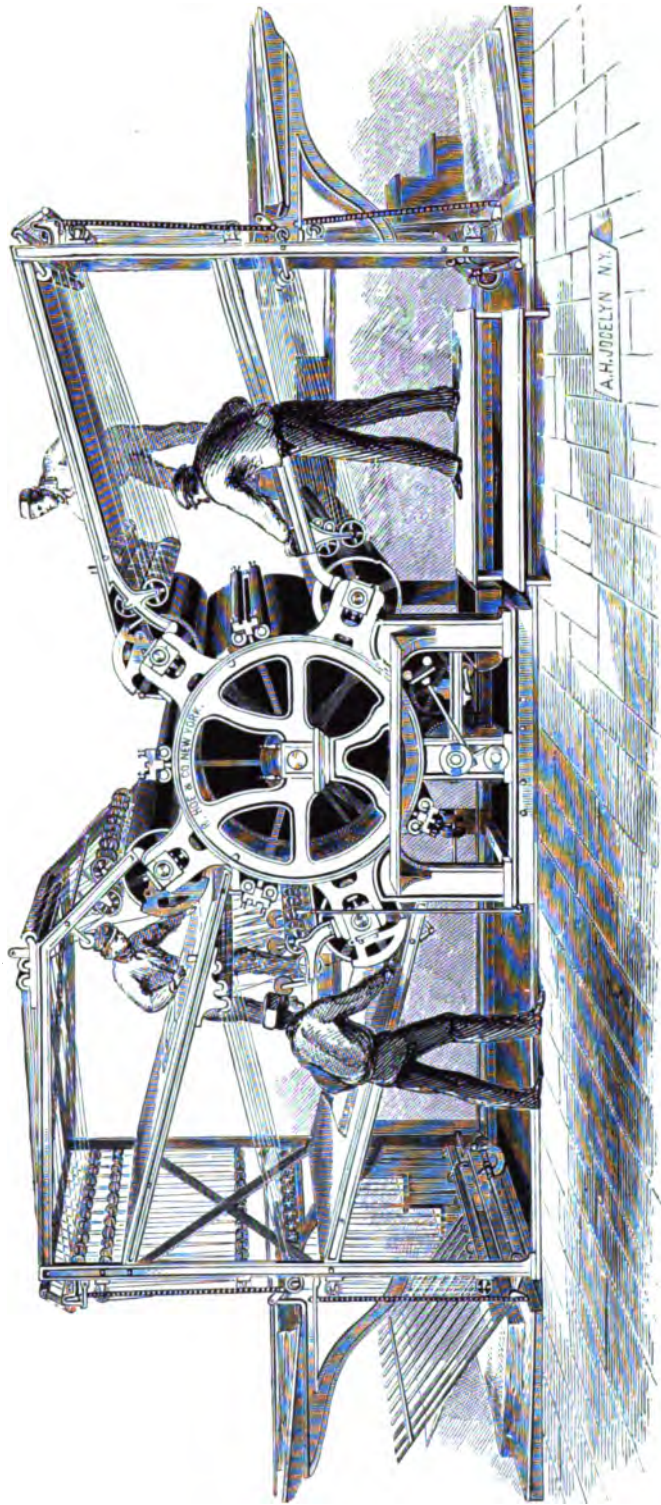

FOUR CYLINDER ROTARY TYPE-REVOLVING PRESS





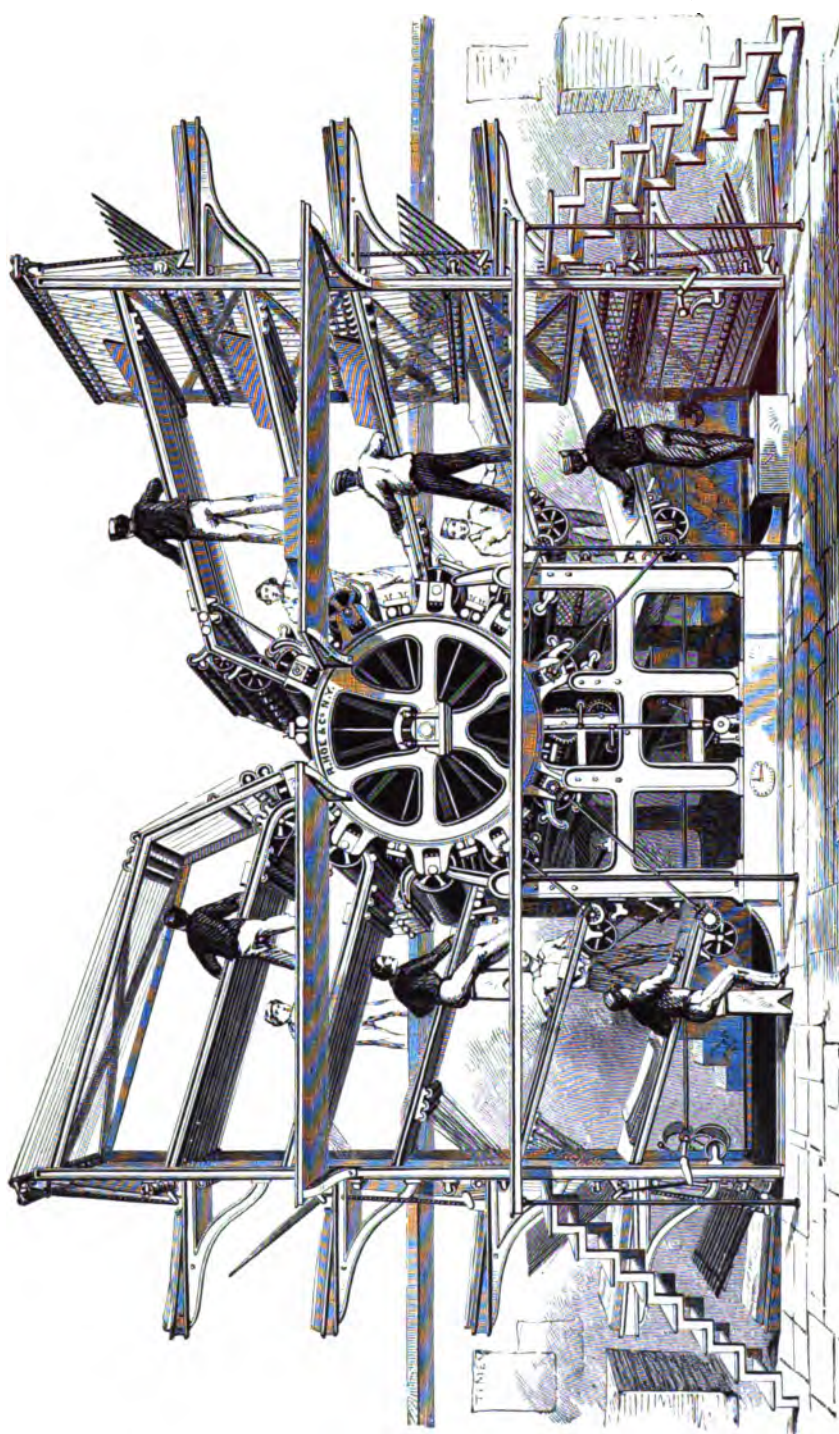

TEN CYLINDER ROTARY TYPE-REVOLVING PRESS



## ROTARY TYPE-REVOLVING PRESS

an end to all enterprise in French newspaper publishing. The English, always slow to adopt improvements, did not appreciate the value of these presses until the year 1856, when Edward Lloyd of "Lloyd's Weekly Newspaper" in London, having seen the one in the office of "La Patrie," ordered a "Six-Cylinder" machine. This was erected in his office in Salisbury Square, Fleet Street, London, in the following year. It was no sooner in operation and seen by the other newspaper proprietors than orders were received from the London "Times" for two "Ten-Cylinder" presses, to replace the Applegath machine they were then using. The order for these machines was a gratifying tribute to American ingenuity, for the "Times" in December, 1848, in an article on the starting of the Applegath vertical cylinder press, stated that "No art of packing could make the type adhere to a cylinder revolving around a horizontal axis and thereby aggravating centrifugal impulse by the intrinsic weight of the metal." Eventually orders from almost all of the leading newspapers in Great Britain and Ireland were received.

In the meantime various experiments had demonstrated the possibility of casting stereotype plates on a curve. The process was brought to perfection by the use of flexible paper matrices, upon which the metal was cast in curved moulds to any circle desired, and these plates were placed upon the Hoe "Type Revolving Machine" upon beds adapted to receive them instead of the type forms. The newspaper publishers were thus enabled to duplicate the forms, and run several machines at the same time with a view of turning out the papers with greater rapidity. In some large offices, such as the New York "Herald," London "Daily Telegraph," and the London "Standard," as many as five of these machines were in constant operation. About this time the stamp duty in England of one penny upon each sheet of printed matter was repealed. This in itself aided materially in the development of the newspaper press.

## APPLEGATH'S TYPE-REVOLVING PRESS

After the return of Koenig to Germany, an Englishman named Applegath, in connection with a machinist named Cowper, made various improvements, mostly in the way of simplifying Koenig's presses. After many experiments, they in 1848 constructed for the London "Times" an elaborate machine, entirely upon the cylindrical principle. All of the cylinders of this machine instead of being horizontal, as in presses heretofore used, were vertical. The type was placed upon a large upright central cylinder, but the circumference instead of presenting a complete circle represented as many flat surfaces as there were columns in the newspaper, the forms thus being polygonal. Around this central or form cylinder were placed eight smaller vertical cylinders for taking the impression, inking rollers being introduced to ink the type as it passed alternately from one of these impression cylinders to another. The sheets were fed down by hand from eight flat horizontal feed-boards through tapes; then grasped by another set of tapes and passed sideways between the impression cylinder and the type cylinder, thus obtaining sheets printed upon one side. The impression cylinder delivered them, still in a vertical position, into the hands of boys, one stationed at each cylinder to receive them. The results obtained from this machine were in a measure satisfactory, as the number of papers printed per hour upon one side, from one form of type, was materially increased; not, however, in proportion to the number of impression cylinders placed around it, as the press at its best could produce but 8,000 impressions per hour, on one side of the sheets. Having devised no means to lock up the type other than in flat columns, the polygonal form was a necessity, and the irregularities in it were made up by underlying the blankets on the impression cylinders to take up these inequalities. Although this press, used in the London "Times" office, was the only one of the kind ever made, its size and importance warrant some record and description of it. This

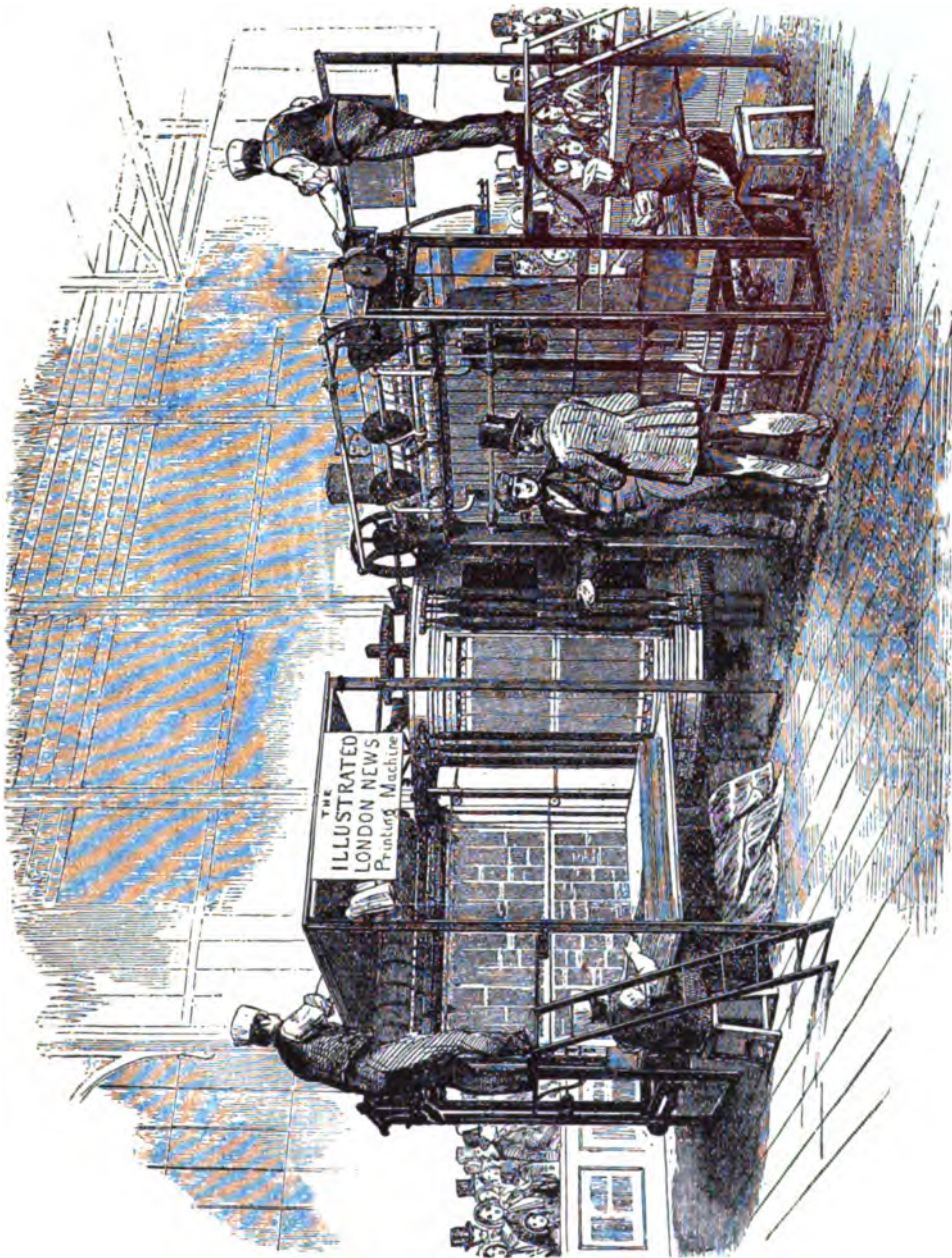

APPLEGATH'S TYPE-REVOLVING PRESS



## BULLOCK PRESS

machine was taken out to make way for Hoe Type Revolving Presses.

In 1835 Sir Rowland Hill had suggested the possibilities of a machine which should print both sides at once from a roll of paper. It is well known that for many years cotton cloths had been printed in this way, the cylinders being engraved and the cloth after printing being reeled up again. The suggestion, however, was accompanied by no practical knowledge as to the details, and, above all, no practical provision for the rapid cutting off and delivery of the paper either before or after it had been printed. It remained for an American, William Bullock, of Philadelphia, to construct, in 1865, the first printing machine to print from a continuous web or roll of paper. His machine consisted of two pairs of cylinders, i. e., two form or plate cylinders and two impression cylinders. The second impression cylinder was made of large size to provide additional tympan surface, to lessen the offset from the first printed side of the paper. The stereotype plates were not made to fill the whole circumference of each of the form cylinders, as the sheets were cut before printing. One difficulty he had to contend with was the cutting off of the sheets with sufficient accuracy and rapidity. This he accomplished by severing them by means of knives in cylinders. The sheets were then carried through the press by tapes and fingers, and delivery sought to be accomplished by means of a series of automatic metal nippers placed upon endless leather belts at such distance apart as to grasp each sheet successively as it came from the last printing cylinders. This machine was put up in several offices and rejected because of its unreliability, especially in the delivery of the papers, but it was finally so far perfected that it came into use to a considerable extent.

Meanwhile the proprietors of the London "Times" inaugurated experiments with the view of making a rotary perfecting press, and finally started the first one in that office about 1868. It was



## LONDON TIMES ROTARY MACHINE

similar in construction to the "Bullock" press so far as the printing apparatus was concerned, excepting that the cylinders were all of one size and placed one above the other. The sheets were severed after printing, brought up by tapes, and carried down to a sheet flier which moved back and forth, and "flirted" the sheets alternately into the hands of two boys seated opposite one another on either side of the sheet flier.

Marinoni, of Paris, also devised a machine on a similar principle, making the impression and the form cylinder of one size, and placed them one above the other. The "Marinoni" machine had separate fly boards for the delivery of the sheets.

In 1871 R. Hoe & Co. also turned their attention to the construction of a rotary perfecting press to print from a roll or continuous web of paper.

As before stated, the greatest difficulties to be encountered were:—

First. The set-off of the first side.

Devices were used to overcome this and the ink-makers were induced to pay special attention to the manufacture of rapid-drying or non-setting-off inks.

Second. The difficulties in obtaining paper in the roll of uniform perfection and strength. The paper-makers were led to make a study of producing large rolls of paper meeting these requirements, and became much more experienced in its manufacture. The "Walter" press in the "Times" office had necessitated a very strong and expensive paper, which could not be afforded by the cheap daily press.

Third. The difficulty of the rapid severing of the sheets after printing.

Fourth. A reliable and accurate delivery of the printed papers.

These last two operations were not accomplished satisfactorily

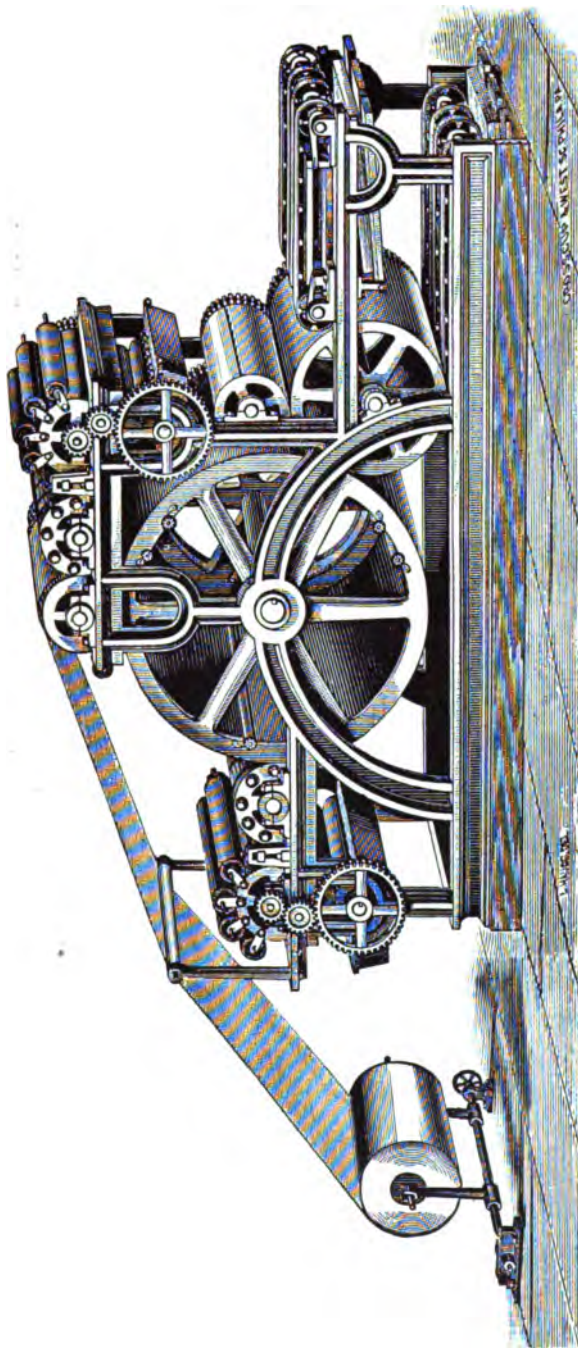

**BULLOCK PRESS**



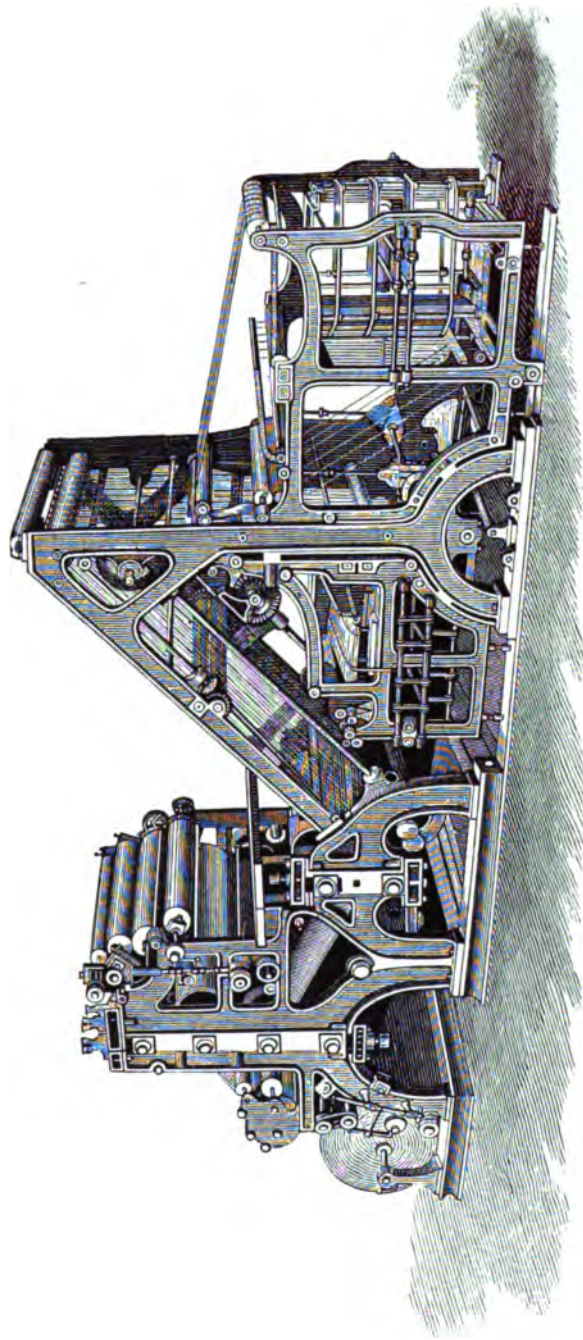

LONDON TIMES ROTARY MACHINE



## FIRST HOE WEB PRESS

until the appearance of the Hoe machine. In this press the sheets were not entirely severed by the cutters, but simply perforated after the printing. They were then drawn by accelerating tapes, which completely separated them, onto a gathering cylinder so constructed that six perfect papers, or any other desired number, could be gathered one over the other. These, by means of a switch, were at the proper moment turned off onto one sheet flier, which deposited them on the receiving board. This gathering and delivery cylinder, patented by Stephen D. Tucker, a member of the firm of R. Hoe & Co., solved the problem of rapid flat delivery. The first of these machines was placed in the office of "Lloyd's Weekly Newspaper," in London, and the first one used in the United States in the "Tribune" office in New York. There was no limit to their capacity for printing excepting the ability of the paper to stand the strain of passing through the press, which produced, when put to its speed, 18,000 perfect papers an hour, delivered accurately on one feed-board. The average speed, however, in printing offices was 12,000, although in some offices they were run at about 14,000 per hour.

The "Walter" press, made by the London "Times," was used by it, and also by the London "Daily News" and by the New York "Times." Further than that it made no progress and has now gone entirely out of use, the presses of this kind in the London "Times" office having been replaced by machines made by R. Hoe & Co. Meantime their machines were adopted by most of the large newspapers in the United States and Great Britain.

These new methods, of course, entirely superseded the "Hoe Type Revolving Machine," which had reigned supreme in the newspaper world for over twenty years, and of which one hundred and seventy-five had been made, almost all of which have now disappeared.

Up to the middle of the last century the paper had been

## FIRST HOE WEB PRESS

made from rags, but as these became unobtainable in sufficient quantity some substitute had to be found. First straw and afterwards wood pulp was successfully employed, and paper made from the latter is now in universal use. Its cheapness (averaging now about three cents per pound) materially aided the newspapers, and stimulated the printing machine manufacturers to renewed efforts in devising presses of still greater speed and efficiency.

It was desirable also that the papers should be delivered folded ready for the carrier or mail. The first apparatus to accomplish this was similar in design to the hand-fed folding machine in common use in printing offices. The sheets, fed separately into these machines, were carried by tapes running upon pulleys under striking blades, which forced them between pairs of folding rollers. After the first fold they were again carried in a similar manner under striking blades, placed at right angles to the first, and again struck down between rollers to receive a second fold. This action was continued until the desired number of folds had been secured. Folders of this description were attached to the fast presses, but none made could be worked at a greater speed than about 8,000 per hour, until in 1875 Stephen D. Tucker patented a rotating folding cylinder which folded papers as fast as they came from the press, or 15,000 in the hour. The striking blade folders were used in the "Bullock" press, in machines made by C. Potter, Jr., & Co. and others. Andrew Campbell, a printing press manufacturer, also constructed a rotary perfecting press, but his devices were not original. Four or five machines were made by him, and these soon went out of use.

The first folders made by Hoe & Co. consisted of the combination of a "gathering cylinder" with a rotary folding cylinder and tapes conveying the printed sheets under horizontal folding blades, somewhat similar to those before described, which thrust them at the proper moment between folding rollers placed at alter-

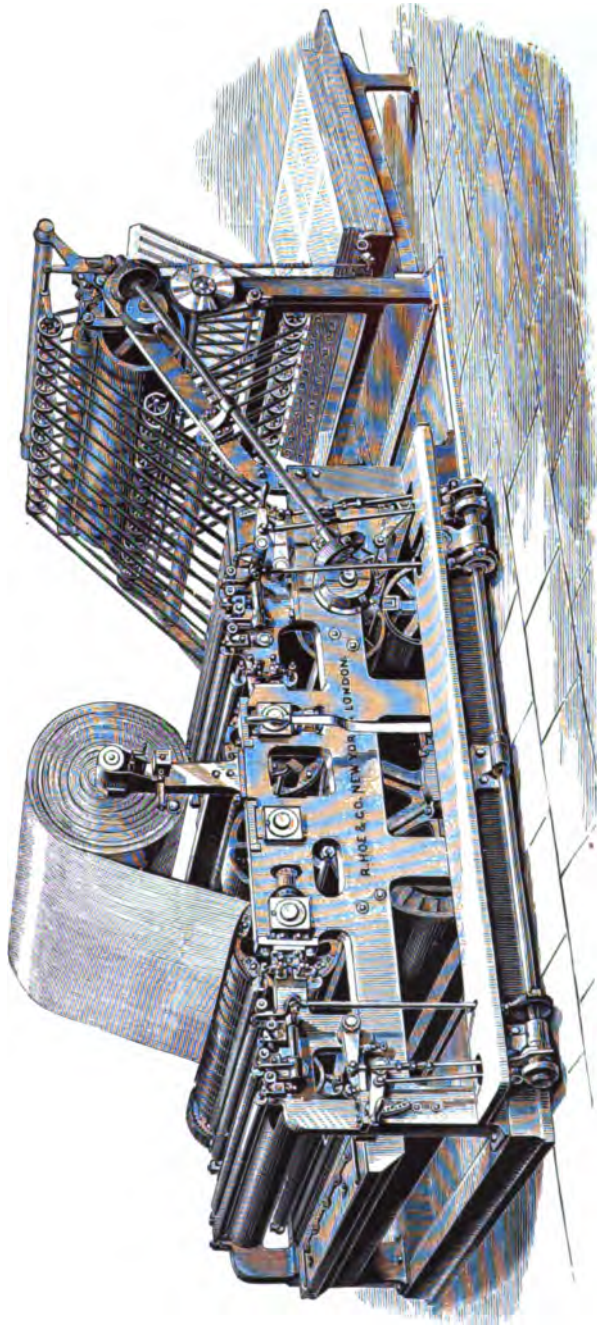

FIRST HOE WEB PRESS





## FIRST HOE WEB PRESS

nate angles, finally delivering them on travelling belts by a small flier. The first of these folding machines were put upon the presses made for the Philadelphia "Times" and operated in the Centennial Exhibition, in 1876.

These folders, however, were only the commencement of a long series of experiments undertaken by the makers in the development of still faster printing and folding mechanisms, and from this time forward the progress made has been phenomenal. With great ingenuity, added to long experience, and by the acquisition and adaptation of every device which should aid them in their efforts, Hoe & Co. succeeded in providing machines of unrivalled designs, efficiency and speed.

About 1876 Messrs. Anthony & Taylor of England (the former one of the owners of a newspaper in Hereford) took out patents for devices by which the webs of paper could be turned over after printing on one side and the opposite or reversed side presented to the printing cylinder. Mr. Hoe, who was in England at the time, appreciating the possible use and development of these patents, became possessed of them for England and the United States.

E. L. Ford, engaged in the publication of a newspaper in New York, patented the uniting of the product of two or more printing mechanisms and thus producing (in restricted form) a multiple number of pages at one time. He was unable, however, to develop his plans to any practical result; but deserves the credit of being the first to patent, if not to conceive, the idea of the association of printed sheets for this purpose.

In the various experiments of Hoe & Co. bearing upon the manipulation of webs of paper some of their devices appeared to encroach upon patents secured by Luther C. Crowell, inventor, of Boston, who had made an ingenious machine for forming paper bags. These patents were immediately secured by purchase and the experimental work proceeded with the view of adapting some of them to

## DOUBLE SUPPLEMENT PRESS

the requirements of the printing press. After many efforts, and the failure and destruction of several machines which had been constructed at great expense, the Hoe "Double Supplement" machine was produced, the first one being purchased by James Gordon Bennett of the New York "Herald" and put to work in his office. The result of these efforts has been, for a third time, a complete revolution of the methods of fast newspaper printing. The most remarkable features of this machine are: Its extreme simplicity, considering the varied work it performs, and its great speed, accuracy and efficiency. It turns out either four, six, eight, ten or twelve page papers at 24,000 per hour, and sixteen page papers at 12,000 per hour; the odd pages being in every case accurately inserted and pasted in, and the papers cut at top and delivered folded. This machine is constructed in two parts, the cylinders in one portion being twice the length of those in the other; the short cylinders being used for the supplements of the paper when it is desired to print more than eight pages. The plates being secured on the cylinders, the paper enters from the two rolls into the two portions of the machine, through each of which it is carried between the two pairs of type and impression cylinders, and printed on both sides, after which the two broad ribbons or "webs" pass over turning bars and other devices, by which they are laid evenly one over the other, and pasted together. The webs of paper then pass down upon a triangular "former," which folds them along the center margin. They are then taken over a cylinder, from which they receive the final fold, a revolving blade within this cylinder projecting and thrusting the paper between folding rollers, while at the same moment a knife in the same cylinder severs the sheet, and a rapidly revolving mechanism, resembling in its motion the fingers of a hand, causes their accurate disposal upon traveling belts, which convey them on for final removal. From this rather summary description it will be apparent that the principle of retaining the paper in the web, or unsev-

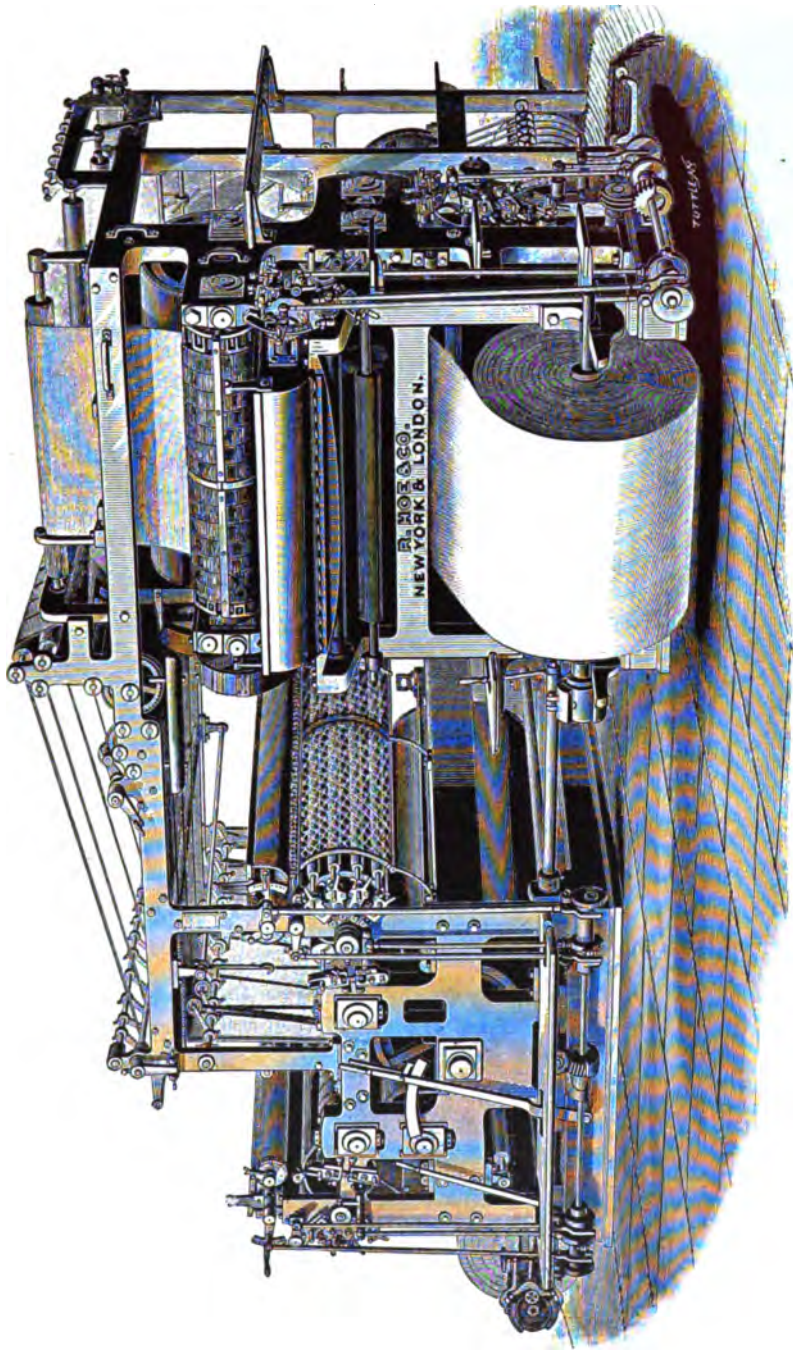

DOUBLE SUPPLEMENT PRESS



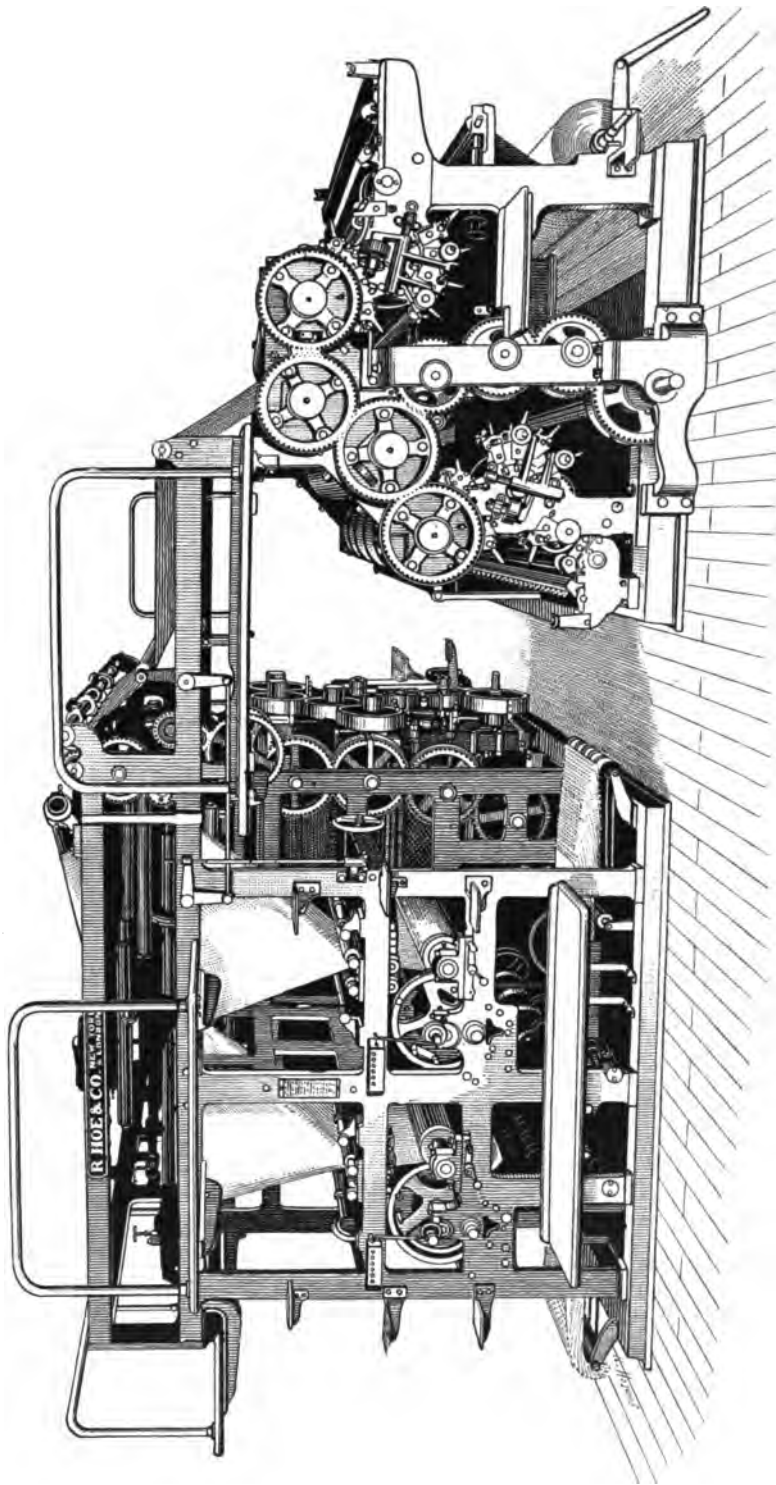

QUADRUPLE PRESS



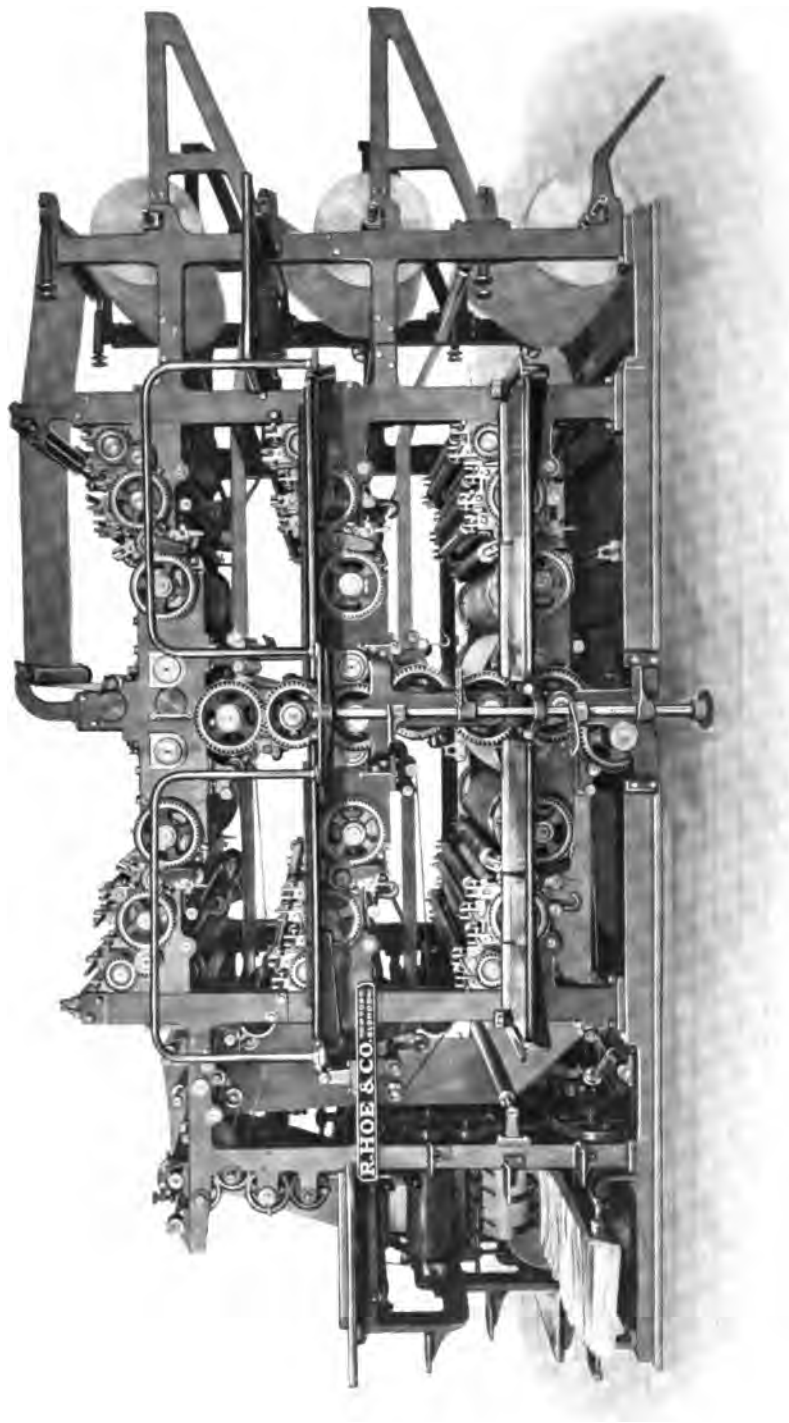

STRAIGHT-LINE PRESS





## QUADRUPLE PRESS

ered form, up to the final fold and delivery, and performing all the operations without retarding the onward run of the paper, effectually prevents chokes or stoppages through any miscarriage of sheets severed before the folding. Several hundred of these machines have been made and put in operation by the United States ; and in offices of the large newspapers in Great Britain and other countries.

Previous to the introduction of the "Double Supplement" press, however, Hoe & Co. had made what is known as the "Double Perfecting" machine. The success of this press, which embraces substantially the printing and folding devices embodied in the "Double Supplement" machine, was the connecting link between the ordinary "single" or two-page-wide press and the "Double Supplement" machine.

The next improvement in fast presses was the construction of the machine known as the "Quadruple" Newspaper Press. This was a step in advance of anything heretofore attempted. The first one was constructed in 1887 and placed in the office of the New York "World." The same principles were embraced in this as in the "Double Supplement," but developed to a greater extent. The supplement portion of the press was increased in width. By means of ingenious arrangements and manipulation of the webs of paper this press was made to produce eight-page papers at a running speed of 48,000 per hour ; also 24,000 per hour of either ten, twelve, fourteen or sixteen page papers ; all delivered with great exactness and perfection ; cut at the top, pasted and folded ready for the carrier or the mails.

Another form of the Double Supplement and Quadruple machines, embodying substantially the same principles, is what has been termed the "straight-line" press. In this form of construction the cylinders are arranged in horizontal rows, or tiers, one above the other, there being two pairs of cylinders in each tier,

## SEXTUPLE PRESS

with the folding and delivery apparatus at the end of the machine. Some of these presses, made under the patent of Joseph L. Firm, and which belong to R. Hoe & Co., have been constructed.

It was thought that the limit of printing capacity in one machine had been reached in this new invention, but in 1889 the same firm undertook the task of constructing a machine for Mr. Bennett of the "New York Herald," which would even eclipse the "Quadruple" machine, which had, together with the "Double Supplement" press, superseded almost all others in the large offices of the United States, as well as in Great Britain and Australia. The press made for the "New York Herald" and known as the "Sextuple" machine, occupied about eighteen months in construction. It is composed of about sixteen thousand pieces. The general arrangement differs entirely from that of the "Quadruple" machine. The form and impression cylinders are all placed parallel, instead of any being at right angles as in the "Quadruple" and "Double Supplement" Presses. To give an idea of this machine, we cannot do better than to quote the description of it in the "New York Herald" of May 10th, 1891.

"The new Hoe press which is being set up in the 'Herald,' Building is nothing less than a miracle of mechanism. To say that it is the only one of the kind ever built and that it throws all previous inventions into the background are facts which the following figures abundantly prove.

"Its consumption of white paper is so astounding that even the imagination grows tired and sits down to catch its breath. It is fed from three rolls, each being more than five feet wide. When it settles down to show its best work it will use up in one hour nearly twenty-six miles of this paper, or to make the matter more significant, it will use up about fifty-two miles of paper the ordinary width of the 'Herald' every sixty minutes.

"Our readers will be startled to learn that it can print and fold

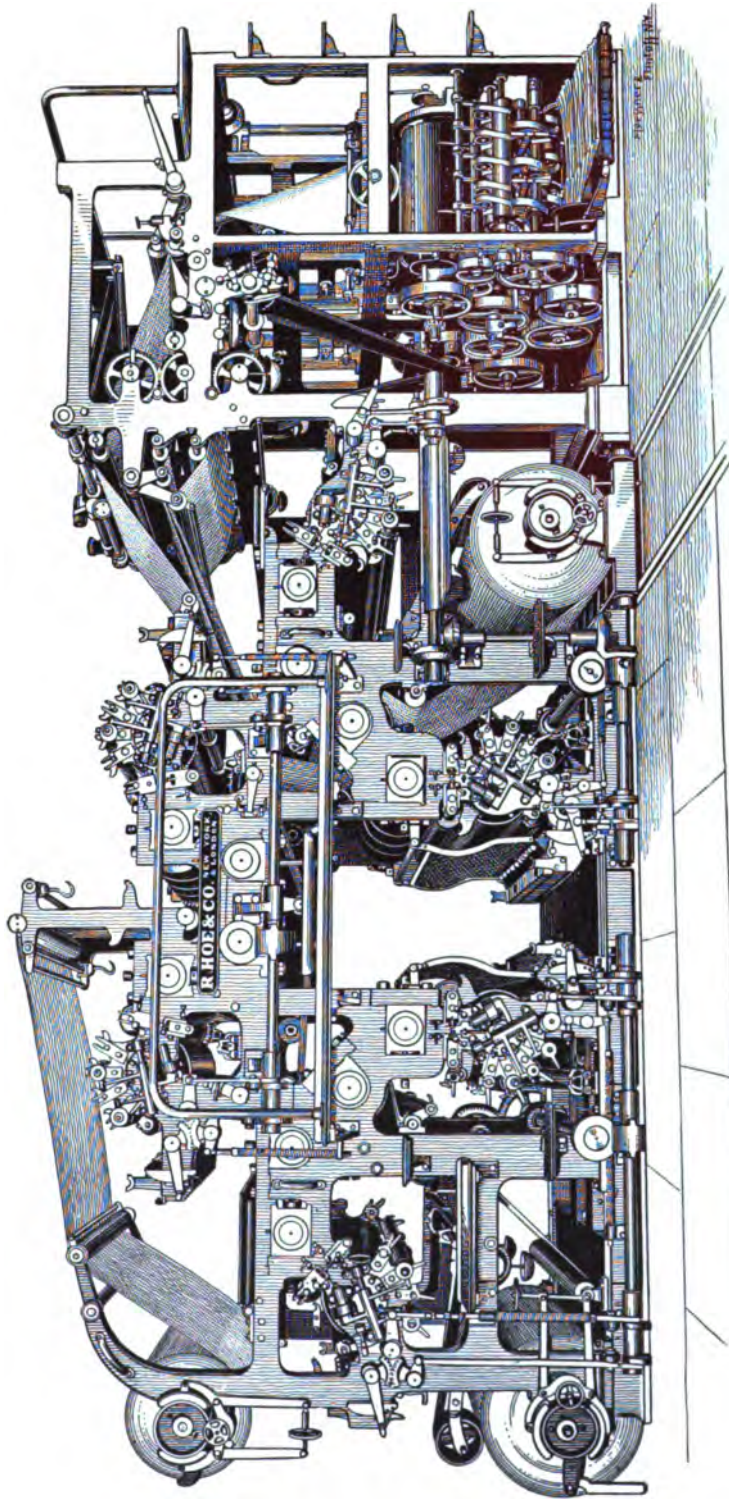

SEXTUPLE PRESS



## SEXTUPLE PRESS

ninety thousand four-page 'Heralds' in an hour. This is, to the mind, which is not versed in the problem of rapid printing, a feat which makes Aladdin's lamp an old woman's fable. Ninety thousand per hour means fifteen hundred copies per minute, or twenty-five copies for every second of time ticked by the clock in Trinity's steeple.

"It is, of course, the last and best result of modern invention—the highest attainment of genius at the present time.

"This new press will print, cut, paste, fold, count and deliver 72,000 eight-page 'Heralds' in one hour, which is equivalent to 1,200 a minute and 20 a second.

"It will print, cut, paste, fold, count and deliver complete 48,000 ten or twelve-page 'Heralds' in one hour, which is equivalent to 800 a minute and a fraction over 13 a second.

"It will print, cut, paste, fold, count and deliver complete 36,000 sixteen-page 'Heralds' an hour, which is at the rate of 600 a minute or 10 a second.

"It will print, cut, paste, fold, count and deliver complete 24,000 fourteen, twenty or twenty-four page 'Heralds' an hour, which is at the rate of 400 a minute, or very nearly seven a second.

"This is lightning work with a vengeance and yet it is possible that there may be some who read this who will live to call it slow. That will probably be when they have found out all about how to put a harness on electricity. No one can predict when inventive genius will reach its limit in the printing press. But for the present this new press marks high water mark.

"Before this press was built the fastest presses in the world were Hoe's 'Quadruple' Presses, of which the 'Herald' has two. These presses turn out 48,000 four, six or eight-page papers an hour, 24,000 ten, twelve, fourteen or sixteen-page papers an hour, and 12,000 twenty or twenty-four-page papers an hour, all cut, pasted and folded.

## SEXTUPLE PRESS

“This new press has a well-nigh insatiable appetite for white paper. To satisfy it, it is fed from three rolls at the same time, one roll being attached at either end of the press and the third suspended near the center. It is the only press that has ever been able to accomplish that feat. Each roll is sixty-three inches wide, or twice the width of the ‘Herald.’ When doing its best this press will consume  $25\frac{7}{8}$  miles of sixty-three-inch-wide paper—equivalent to  $51\frac{3}{4}$  miles of paper the width of the ‘Herald’—in one hour, and eject it at the two deliveries in the shape of ‘Heralds,’ each copy containing an epitome of the news of the world for the preceding twenty-four hours, and each copy cut, pasted and folded ready for delivery to the ‘Herald’ readers. It is a sight worth seeing to see it done. Certainly we know of nothing else which affords such a striking example of the triumph of mechanical genius.

“A man turns a lever, shafts and cylinders begin to revolve, the whirring noise settles into a steady roar, you see three streams of white paper pouring into the machine from the three huge rolls, and you pass around to the other side—it is literally snowing newspapers at each of the two delivery outlets. So fast does one paper follow the other that you catch only a momentary glitter from the deft steel fingers that seize the papers and cast them out.

“The machine weighs about fifty-eight tons. It is massive and strong, with the strength of a thousand giants. And yet though its arms are of steel and its motions are all as rapid as lightning, its touch is as tender as that of a woman when she carries her babe. How else does the machine avoid tearing the paper? It tears very readily, as you often ascertain accidentally when turning over the leaves. Truly wonderful it is, and mysterious to anybody but an expert, how this huge machine can make newspapers at the rate of twenty-five a second without rending the paper all to shreds.

“It has six plate cylinders, each cylinder carrying eight stereotype plates, which represent eight pages of the ‘Herald,’ and six

## SEXTUPLE PRESS

impression cylinders. These cylinders, when the press is working at full speed make 200 revolutions a minute. The period of contact between the paper and the plate cylinders is therefore inconceivably brief, and how in that fractional space of time a perfect impression is made, even to the reproduction of such fine lines as are shown in these illustrations, is one of those things which, to the man who is not 'up' in mechanics, must forever remain a mystery. But that it does it you know, because you have the evidence of your own eyes

"A double folder forms part of this machine. A single folder would not be equal to the task imposed upon it. As it is, this double folder has to exercise such celerity to keep up with the streams of printed paper that descend upon it that its operations are too quick for the eye to follow.

"The press has two delivery outlets. At each the papers are automatically counted in piles of fifty. No matter how rapidly the papers come out, there is never a mistake in the count. It is as sure as fate. By an ingenious contrivance—if I should attempt to describe it more definitely most people would be none the wiser—each fiftieth paper is shoved out an inch beyond the others that have been dropped onto the receiving tapes, thus serving as a sort of tally mark.

"Truly it is a marvelous machine—this Sextuple press. Nowhere will you find a more perfect adaption of means to ends; nowhere in any branch of industry a piece of mechanism which offers a finer example of what human skill and ingenuity is capable of. And it is free from that reproach which is sometimes brought against the greatest triumph of inventive genius in other departments of human activity—that they make mere automatons out of human beings.

"The printing press is synonymous with progress, with the diffusion of knowledge and the spread of ideas. Without the great



## APPLETON ROTARY BOOK PRESS

improvements that have been made in it within the memory of many men now living the modern newspaper, the best friend of liberty, and the greatest foe of tyranny, would be an impossibility. It has more than kept pace with the advancement in other departments of industry. In 1829 the Washington Hand Press was introduced and regarded as quite a mechanical triumph. At its best it printed 250 impressions an hour on one side, or 125 complete newspapers of insignificant dimensions. Now, a little over sixty years later, a machine is brought out which, when the number of papers alone is compared, does 150 times as much work in the same time, and which, if the comparison is extended to the actual amount of printing done, does over 2,000 times as much work."

About 1871 a machine called the "Prestonian" was made by Foster, a machinist of Preston, England, and two or three were set to work, but did not enjoy any great degree of favor. They embodied a combination of the "Hoe Type Revolving Machine" with the "endless sheet perfecting press." The form of type for one side of the paper was placed upon one cylinder, with impression cylinders around it, in the manner of the Hoe press, and the form for the other side on another cylinder, and the paper passed from one set of impression cylinders to the other. The principal objection to this machine was its lack of speed. The same principle, however, had been developed years before in the "type revolving perfecting" presses (made by Hoe & Co.) which have two sets of type forms on separate large cylinders, the sheets being fed in by hand and conveyed from one impression cylinder to the other and against the forms by means of fingers or grippers. The sheets were then delivered on a sheet flier. These presses were especially designed for printing books, of which large numbers were required, such as text books and spelling books. The contents of a whole book could be placed on these cylinders and printed and delivered at one impression. One of these machines constructed in 1852

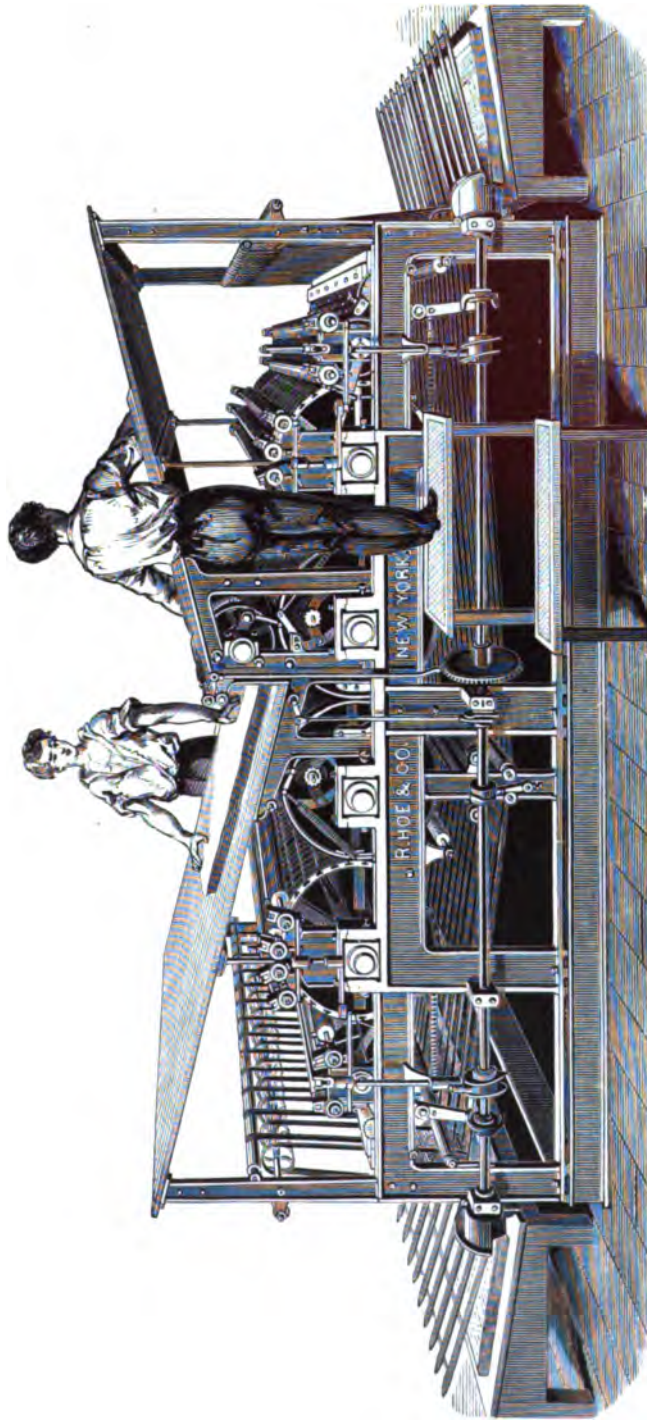

APPLETON ROTARY BOOK PRESS



## ROTARY TYPE-REVOLVING WEB PRESS

(fifty years ago) is still in operation at Messrs. D. Appleton & Co.'s printing office in Brooklyn, as active and efficient as ever.

In 1881 Hoe & Co. turned their attention to the making of a machine which should print FROM ONE FORM OF TYPE at a greater speed than had ever yet been attained. The result was the "Rotary Type Endless-sheet Perfecting Press." The principle of this

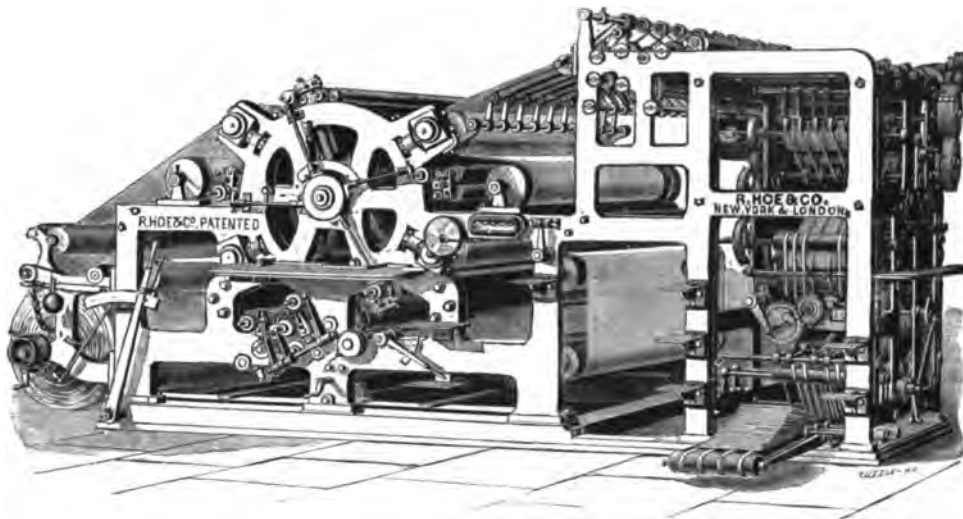

ROTARY TYPE-REVOLVING WEB PERFECTING PRESS

machine was in a measure that of their "Type-Revolving" press. The forms of type for both sides of the paper were placed on a central cylinder, which was surrounded by impression cylinders and inking rollers.

There, were, however, no feeders and no grippers. The roll of paper was placed at the end of the press, passed around the impression cylinders arranged at one side of the form cylinder, and then turned upside down at the lower part of the machine, thence being carried upwards. The opposite or unprinted side was presented in turn between each impression cylinder and the forms. If four impres-

## ROTARY TYPE-REVOLVING WEB PRESS

sion cylinders were placed around the central cylinder then at each revolution of the latter four perfect papers were printed. If eight impression cylinders were placed around the central cylinder then eight perfect papers were printed at one revolution of the main or form cylinder. The speed attained by this machine with four impression cylinders was about 12,000 per hour, and from machines with eight impression cylinders 24,000 copies per hour were printed. This press was especially adapted for afternoon papers when the time or expense necessarily involved in stereotyping could not be afforded. The majority of the machines made were provided with four impression cylinders only. In the machines with eight impression cylinders two rolls were used, one at either end of the machine, the paper from each roll passing under the two first impression cylinders on either side, each web then being turned over, and paper passed between the two remaining cylinders on either side to print the opposite sides of the sheets.

In this machine a folding apparatus was placed at each end to receive the product of the rolls, but in the machine with four impression cylinders only one folder was placed, at the end of the machine opposite that at which the paper entered.

The experience gained in the construction of these fast newspaper machines, and the accumulation of patented devices entering into them, which were numbered by the score, had their influence in the improvements which were made upon presses for the printing of weekly newspapers, periodicals and magazines.

In 1888 was introduced a patented Hoe machine called the "Three-page-wide Press." It has a capacity of printing, perfecting and delivering two-page papers, with one fold, at the rate of 60,000 per hour ; four-page papers, with two folds, at 24,000 per hour, six-page papers at 24,000 per hour ; eight-page papers, folded twice, or to carrier size, at 12,000 per hour, and twelve-page papers, folded in the same manner as the eight-page, at the same speed, viz., 12,000

## THREE-PAGE WIDE PRESS

per hour; all the supplement sheets being inset and pasted if desired.

The prominent features of this machine are:

The outside pages may receive the first or the last impression

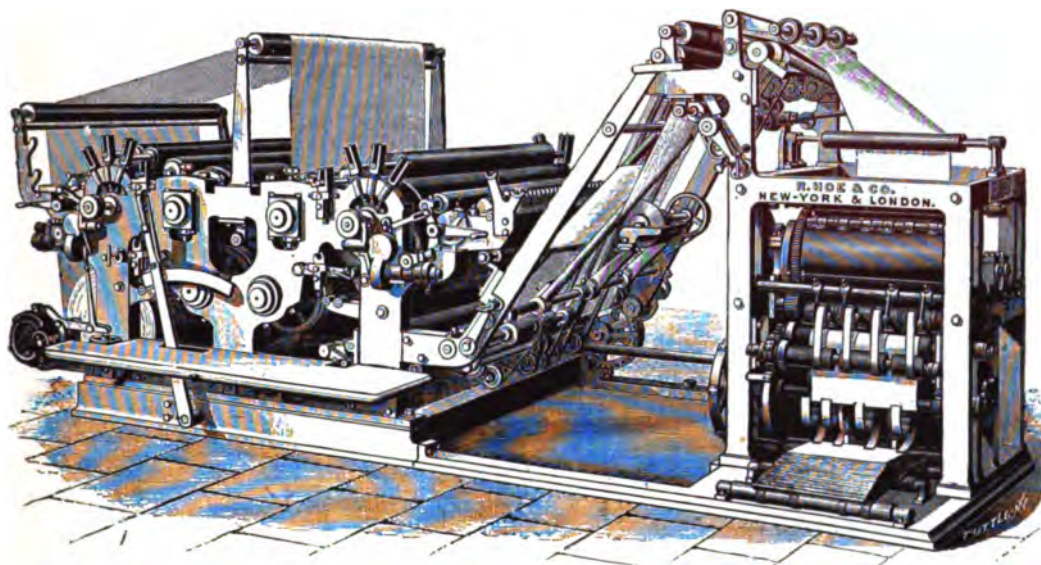

THREE PAGE WIDE PRESS

at will, thus enabling large cuts and other similar work to be printed without offset.

Grippers and horizontal folding knives and all tapes but short leaders are done away with in the delivery and folding mechanisms, the movements being all rotary.

The press occupies but a small space on the floor, being 6 feet 1 inch high, 8 feet wide and 15 feet 5 inches long over all.

In 1889 Hoe & Co. constructed a patented perfecting machine in which the plates, or forms, for both sides are placed upon one cylinder, one side of the form of matter being placed upon one end,

### THREE-PAGE WIDE PRESS

or half of the cylinder, and the other side upon the opposite portion of the cylinder. One impression cylinder only is used, and the inking apparatus is greatly extended. This machine is remarkable for the great variety of work it will do. At a high rate of speed, sheets of eight, sixteen, twenty-four and so on up to ninety-six or one hundred and twenty-eight pages may be printed and delivered folded in either 12mo, 8vo, 4to or folio sizes, ready for the binder. The press does the work of ten flat-bed cylinder presses and ten hand-feed folding machines. The paper is supplied to the machine from the roll, and after printing passes over the "former" into the folding machine, where the folding and cutting cylinders produce the required number of pages in the form desired. Curved electrotypes are now made successfully and this press was the first to bring the printing of the average book and catalogue within the range of web press work. While in general principles this machine is similar to the large newspaper perfecting presses, though very much smaller in bulk, it has increased facilities for distribution, and finer adjustments throughout. The plates admit of underlays and overlays the same as on a flat-bed press. There are no tapes, the folding being done on rollers and small cylinders without smutting the printing. In the folding apparatus there are knives which cut the sheet into the right size for folding, after which they are automatically delivered counted in lots of fifty each. The speed on a thirty-two page form is about 16,000 copies per hour. This style of machine is probably destined to revolutionize book and pamphlet printing, as it combines the finest construction and facility of operation with the greatest speed.

In 1886 a further advance was made toward perfection in the rotary system of printing as adapted to doing fine work, in the construction for Theodore L. De Vinne, the printer of the "Century" Magazine, by Hoe & Co., of a perfecting press to do the plain forms of that periodical. The machine was described in the

## NEWSPAPER AND PAMPHLET PRESS

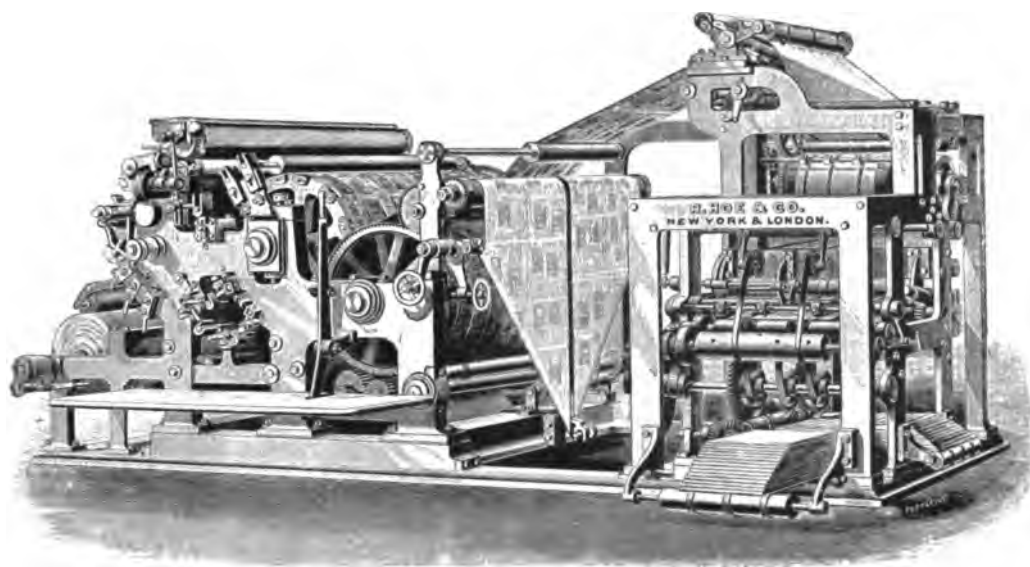

NEWSPAPER AND PAMPHLET PRESS

magazine, in an article written by Mr. De Vinne, here quoted from:

(Extract from article published in the "Century" Magazine, November, 1890.)

"At the end of a long row of machinery stands the web press—a massive and complicated construction, especially built by Hoe & Co. for printing, cutting and folding the plain and advertising pages of the 'Century.' Web presses for newspapers are common enough, but this press has distinction as the first, and for three years the only, web press used in this country, for good book work. At one end of the machine is a great roll of paper more than two miles long when unwound, and weighing about 750 pounds. As the paper unwinds it passes first over a jet of steam which slightly dampens and softens its hard surface and fits it for receiving impressions, without leaving it wet or sodden. It passes under a plate cylinder, on which are thirty-two curved plates, inked by seven large rollers, which print thirty-two pages on one side. Then it passes around a reversing cyl-



## NEWSPAPER AND PAMPHLET PRESS

inder which presents the other side of the paper to another plate cylinder, on which are thirty-two plates which print exactly on the back the proper pages for the thirty-two previously printed. This is done quickly—in less than two seconds—but with exactness. But the web of paper is still uncut. To do this it is drawn upward under a small cylinder containing a concealed knife, which cuts the printed web in strips two leaves wide and four leaves long. As soon as cut the sheets are thrown forward on endless belts of tape. An ingenious but undetectable mechanism gives to every alternate sheet a quicker movement, so that it falls exactly over its predecessor, making two lapped strips of paper. Busy little adjusters now come in play, placing these lapped sheets of paper accurately up to a head and a side guide. Without an instant of delay down comes a strong creasing blade over the long center of the sheet, and pushes it out of sight. Pulleys at once seize the creased sheet and press it flat, in which shape it is hurried forward to meet three circular knives on one shaft, which cut it across in four equal pieces. Disappearing for an instant from view, it comes out on the other side of the upper end of the tail of the press in the form of four folded sections of eight pages each. Immediately after, at the lower end of the tail of the press, out come four entirely different sections of eight pages each. This duplicate delivery shows the product of the press to be at every revolution of the cylinder sixty-four pages, neatly printed, truly cut, and accurately registered and folded, ready for the binder. Two boys are kept fully employed in seizing the folded sections and putting them in box trucks, by which they are rolled out to the elevator, and on these sent to the bindery. This web press is not so fast as the web press of daily newspapers, but it performs more operations and does more accurate work. It is not a large machine, nor is it noisy, nor does it seem to be moving fast, but the paper goes through the cylinders at the rate of nearly two hundred feet a minute. It does ten times as much work as the noisier and more bustling presses by its side.”

## ROTARY ART PRESS

The success of this perfecting press induced the makers to devise a machine on the rotary principle adapted for the finest kind of illustrations—in short, to make a press which should do work as fine as it was possible to do on the hand press or the stop cylinder. The result was the setting up, in 1890, at the De Vinne Press, of a

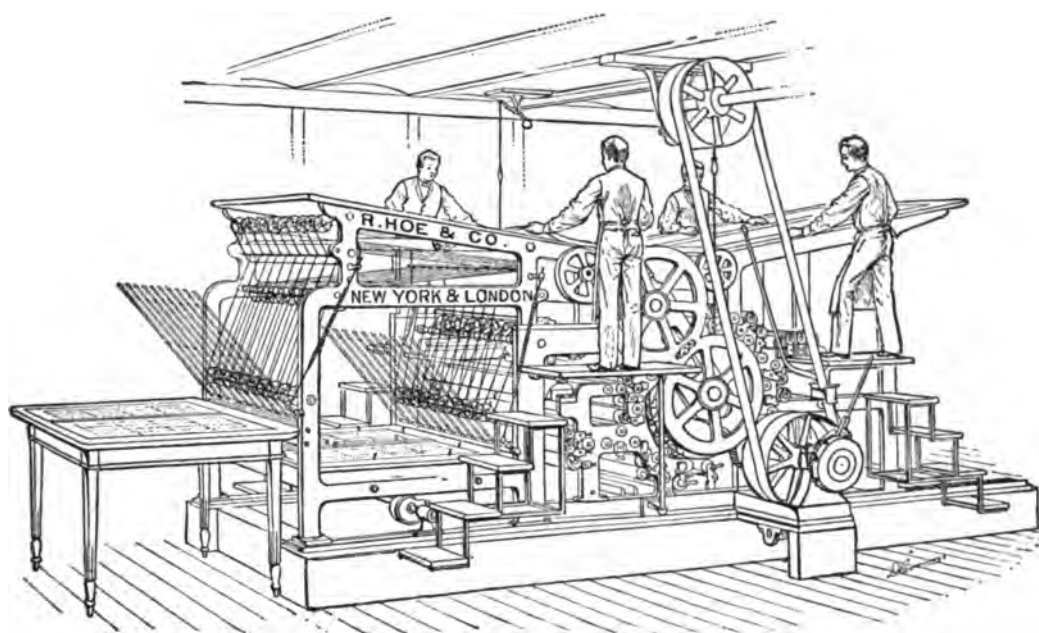

ROTARY ART PRESS

machine known as the “Rotary Art” press. This machine is described in the “Century” of November, 1890, as follows:—  
“Sixty-four plates of the ‘Century,’ truly bent to the proper curve, are firmly fastened on one cylinder sixty inches long, and about thirty inches in diameter; sixteen inking rollers, supplied with ink from two fountains, successfully ink these sixty-four plates with a delicacy and yet with a fullness of color never before attained. The shafts of the impression cylinder and the plate cylinders,  $4\frac{1}{2}$  inches in diameter, do not give or spring under the strongest impression.

## “TIT-BITS” PRESS

Although rigid in every part, in the hands of an expert pressman it can be made responsive to the slightest overlay. This machine is fed by four feeders from single sheets in the usual manner, and does the work of four stop cylinders in superior style. The gain in performance is not as great as the gain in quality of presswork, but quality was considered more than speed. The performance of the machine could have been more than doubled by adding to it other cylinders which would print on both sides of the paper; but careful experiment has proved that the *finest* woodcuts cannot be properly printed with this rapidity. To get the best results the ink on one side of the paper must be dry before it is printed on the other side.”

Among the most interesting modern printing machines are those constructed by Hoe & Co. at their London works, after drawings and patterns sent from New York, for weekly English journals, such as “Tit-Bits,” “Sunday Stories,” and similar periodicals. These machines embody to a certain extent the principles of the “Double Supplement” press before referred to. Double sets of plates are placed upon the main machine, which is capable of taking on an aggregate of twenty-four pages; and by using narrower rolls the number of pages of the body of the journal may be reduced to sixteen or twenty, so that the publisher may have the option of printing his paper either sixteen, twenty or twenty-four pages. In addition to this it prints a cover on a different colored paper, and all at the rate of 24,000 copies per hour; the whole product, including the cover, being cut on the edges and pasted together at the back. The supplement or cover of the press portion, however, instead of having two pairs of cylinders, as in the “Double Supplement” machine, consists of one form cylinder and one impression cylinder. This portion of the machine prints the cover, which is fed from a narrower roll, and, as before stated, of an entirely different color or quality of paper from the body of the journal. The form for one side of the cover is placed on one end of the form cylinder, and

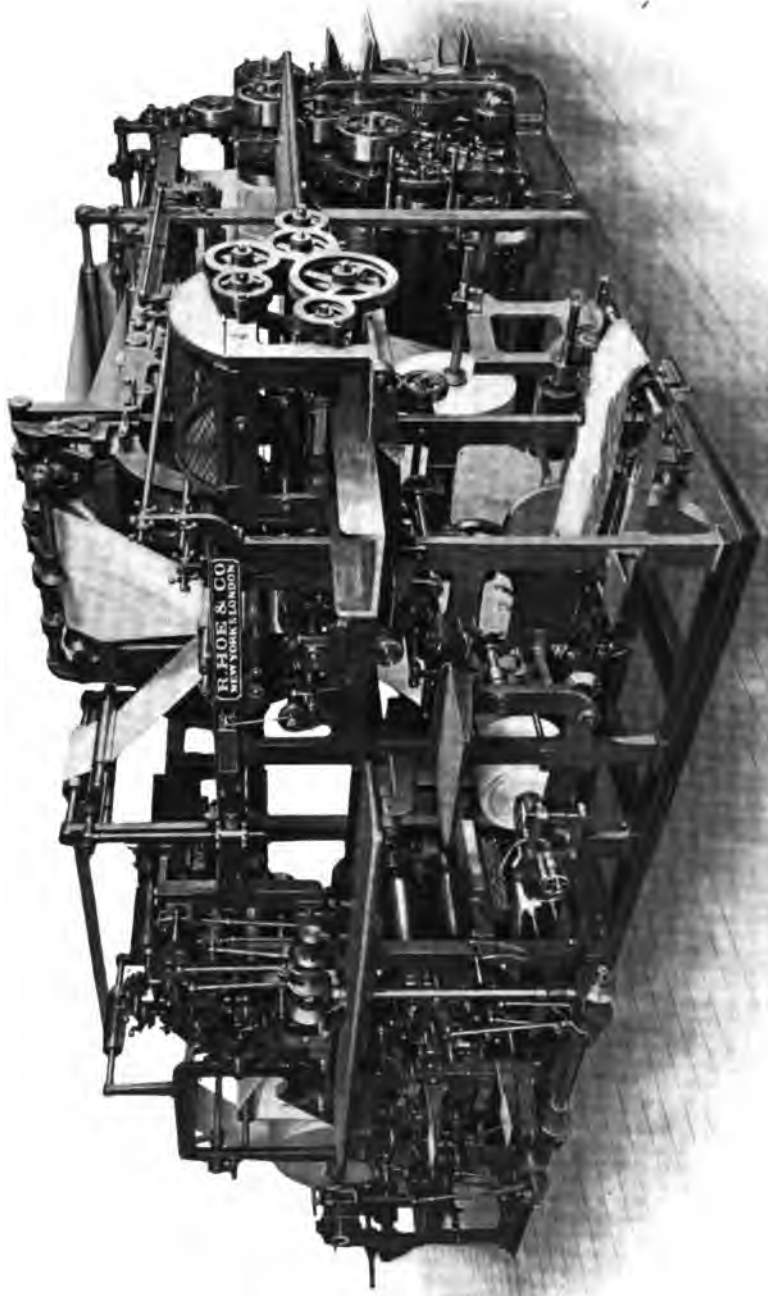

“TIT BITS” PRESS



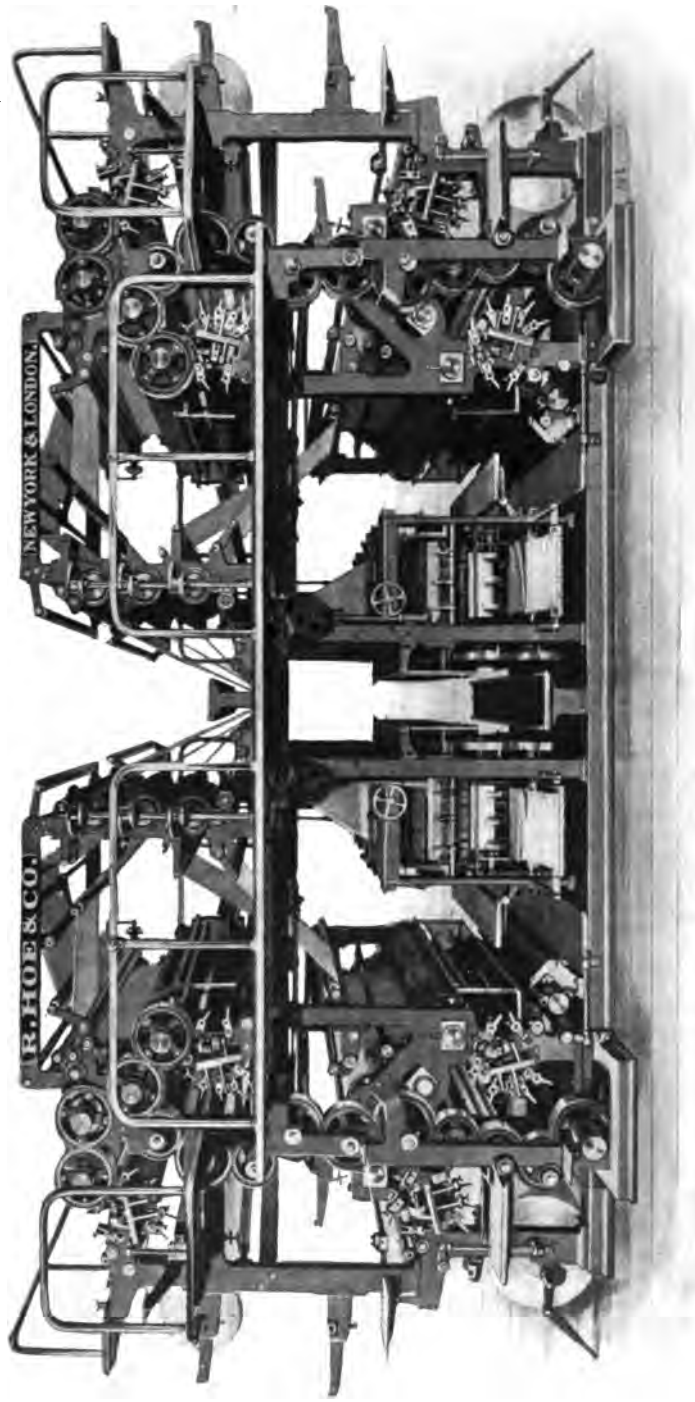

OCTUPLE PRESS



## OCTUPLE PRESS

that for the other side on the other end of the cylinder. This ingenious combination results in the printing of one cover to every copy of the journal issued and no more.

The demand for printed matter seems to increase with the ability to furnish it, and much attention is now being directed to the subject of color printing on the rotary system. From present appearances, and from the enterprise displayed by the publisher, the artist and the press maker, it would seem as though the day is not far distant when this subject alone would furnish matter for a new chapter in the history of the printing press.

It is very difficult to give in a short article even a summary of the various kinds of machines to print newspapers of various sizes, in black as well as in colors, weekly periodicals, magazines, books, pamphlets, in short every class of printing, in connection with folding, which have been evolved and perfected up to the present time. The work still goes on, one step in advance leading to another, until now a printer can obtain a great variety of machines to print from the roll or fed from separate sheets, and which, especially in the production of large numbers, economize both time and labor. Nor is this constant advance in mechanical construction confined to the machines themselves or the manipulation of the paper. It extends to the manufacture of the paper and the inks, although the manufacturers of the latter have not advanced in the same proportion as the paper-maker, who every year produces finer paper in the roll and in greater quantities than ever before.

The latest and most elaborate newspaper machine is the Octuple Perfecting Press with Folders, which prints from four rolls, each four pages wide, and gives (from the four deliveries) a running speed per hour of: 96,000 4, 6 or 8-page papers; 72,000 10-page papers; 60,000 12-page papers; 48,000 14 or 16-page papers; 42,000 18-page papers; 36,000 20-page papers; 24,000 24-page papers.



## DOUBLE SEXTUPLE PRESS

This machine has been further developed into the Improved Combination Octuple (or Double Quadruple) and Color Machine, lately patented by R. Hoe & Co., which, in addition to giving the above mentioned output when printing in black only, will also produce papers in colors at the rate per hour of: 96,000 4-pages; 48,000 6, 8, 10, 12, 14 or 16 pages; 24,000 18, 20, 24 or 28 pages.

R. Hoe & Co. have now in process of construction four mammoth printing machines, which will give a greater product and a greater variety of products than any machines that have hitherto been devised. They are Double Sextuple Presses and so called, but in reality are much more than this, inasmuch as they combine the ability to do printing in colors as well as in black. This machine is composed, so to speak, of two separate, complete printing mechanisms, each fed from three four-page-wide rolls of paper; the apparatus for the gathering and folding of these webs of paper after printing being in the centre between the two sections of the machine. The "formers" and folders (placed back to back) enable a manipulation or gathering of the webs which could not be readily obtained in any other way. All these devices and methods have been patented by Hoe & Co. The following is a summary description of these new machines and what they will accomplish. The two sections may be used separately if desired, as independent machines.

Each of the two portions of the machine is composed of six pairs of cylinders, arranged, with their axles parallel, in three tiers of two pairs each and printing on both sides (or perfecting) three webs of paper from separate rolls, each four pages wide. One of the sections is also arranged so that all six sets of cylinders will print upon a single web in colors and black, this web being associated with the three webs from the other portion to form a colored cover for the products, when required.

The rolls of paper are placed at the end of the machine—

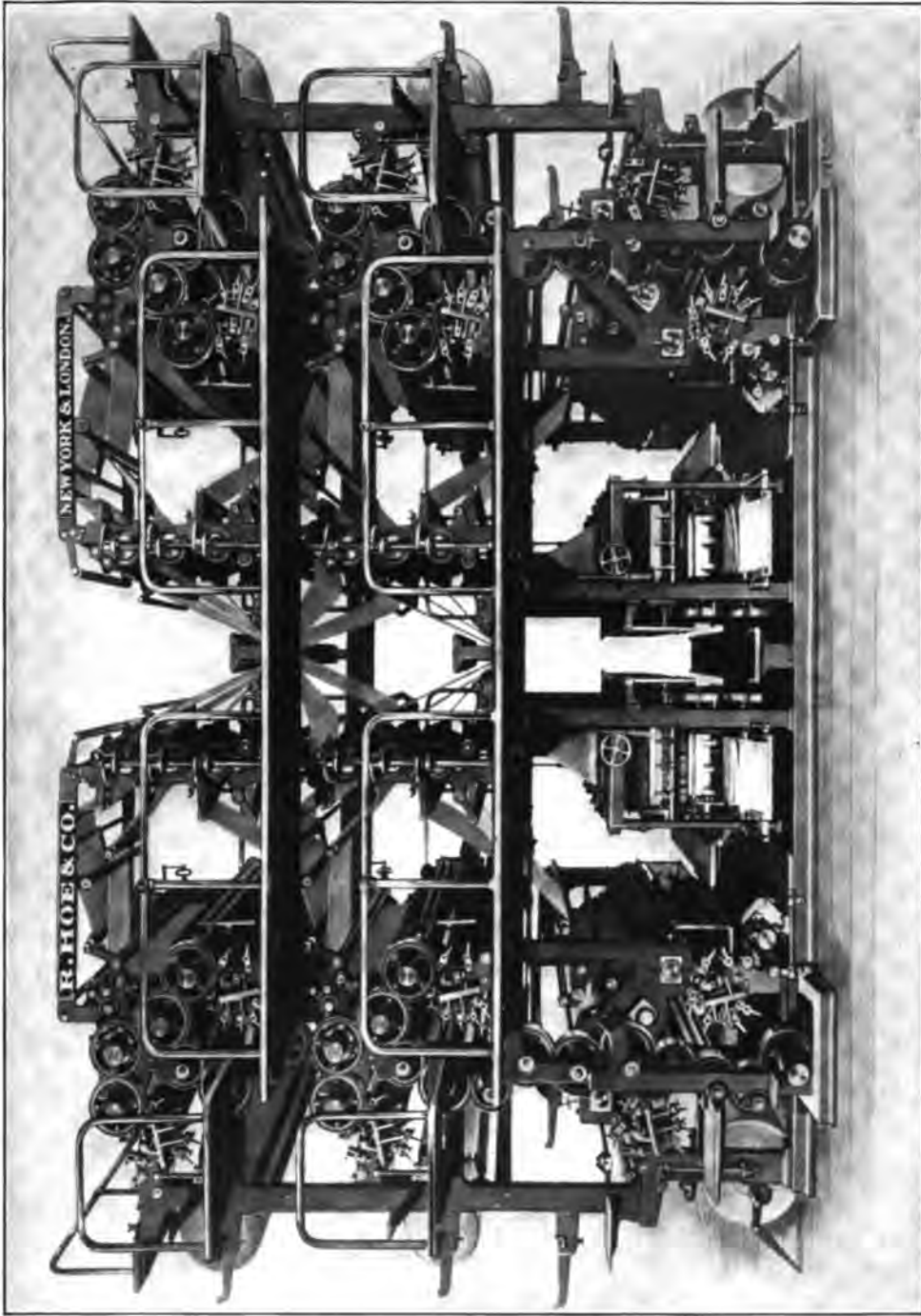

DOUBLE SEXTUPLE PRESS BUILT FOR THE NEW YORK JOURNAL



## DOUBLE SEXTUPLE PRESS

three at each end—and the two folders for each portion are placed back to back midway in the length of the machine. The runs of all the webs are therefore approximately the same and as short as it is possible to have them—a matter of much importance in the running of multiple webs.

Altogether there are twelve plate cylinders in the machine, each carrying eight plates the size of a newspaper page. Either stereotype or electrotpe plates may be used. To receive the latter, which are much thinner than stereotype plates, special base or jacket plates are secured to the cylinders. The ink is applied to the plates by four form rollers, after having been thoroughly distributed by vibrating rollers and cylinders.

The full capacity of the machine, when printing all black, on six rolls, is 96,000 twelve-page papers per hour, and other numbers of pages at proportionate speeds, namely, four, six, eight and ten-page papers, at the same speed as twelve-page; fourteen and sixteen-page papers at 72,000 per hour; eighteen, twenty, twenty-two and twenty-four page papers at 48,000 per hour. The three webs from each portion of the machine are led to the top of the folders, where they are divided along their centre line into webs two pages wide, and then run down each of the four “formers,” by which they are folded along their centre. They are then led through cylinders which cut them into page lengths and give them a fold across the page to half-page size. In this way twenty-four page papers may be obtained at the rate of 48,000 copies per hour, by collecting two twelve-page sections on the cylinder just before the half-page fold is made. Another method of running twenty-four page papers is to associate the six webs, from both portions of the machine, and run them over one pair of “formers,” thus folding all six webs together, or inseting them, in the first fold.

Lesser number of pages may be obtained by making various combinations, the number of which is almost limitless. Angle bars

## DOUBLE SEXTUPLE PRESS

are placed in the machine for transferring half-width webs of paper from one side of the press to the other, facilitating these combinations.

The maximum product of the machine when running as a color press is 48,000 sixteen-page papers per hour, with the two outside pages printed in four colors and black; the other pages in black only. If, however, it is not desired to have so many colors on the outside pages, it is possible to obtain twenty-page papers, at the rate of 48,000 per hour, with the two outside pages in two colors and black; all the other pages in black only. Papers with any number of pages from four to sixteen, with four colors and black on the outside pages, the other pages in black only, can be obtained at a speed of 48,000 per hour. By running the full product of the color section of the machine into one folder and associating therewith webs of paper from the other section of the machine, papers with any number of pages from eight to twenty-four, with the two outside pages and two of the inside pages printed in four colors and black, the other pages in black only, can be produced at a speed of 24,000 per hour.

The dimensions of this machine are as follows: Length, 35 feet; height, 17 feet; width, 9 feet; the weight, about 225,000 pounds; and the number of parts of which it is composed, approximately 50,000.

The last three or four years have also witnessed an immense advance in the art of color printing. The magazine without an elaborate color cover, or perhaps colored illustrations, is now an exception, whereas it was the reverse not long ago. After satisfactory experiments it was ascertained by the writer that, with the inks properly prepared, and suitable plates to print from, colors could be printed almost simultaneously upon the paper, without mingling; in short that the supposed necessity, in much of the work done, of drying the sheets after the impression of each color on the paper, was not necessary

## DOUBLE SEXTUPLE PRESS

for the production of a good quality of printing. Further experiments also proved the mechanical possibility of obtaining most accurate register in printing from a roll and that the number of impressions, or colors, could be increased to advantage. These various experiments resulted in the construction by Hoe & Co. of color presses which were almost simultaneously installed by the proprietors of the New York "Herald" and the New York "World," who commenced the publication of colored supplements, upon a system which has been adopted by the papers in most of the large cities, and which they have never discontinued. The practicability of printing in colors has been so fully demonstrated that color attachments are being added to very many of the large newspaper presses throughout the country.

The most extensive of the color presses, and the largest printing machine ever constructed, is the color press made by Hoe & Co. for the New York "Journal" and now used in printing portions of the Sunday editions of that paper, although others of approximate proportions and capacity have been made for the New York "World," the New York "Herald," the Chicago "Tribune," the Boston "Post" and other newspapers. This machine gives as many as eleven separate impressions, or colors, on a single copy of the paper; that is, it will print in six colors on one side of the sheet and five on the other, or it may be arranged to print three colors on one side and six on the other, giving a speed of about 16,000 eight-page papers an hour, or at every revolution of the cylinders the equivalent of two perfect eight-page papers printed in colors. Four, six, eight, ten, twelve, fourteen, sixteen, twenty, twenty-four, twenty-eight or thirty-two-page papers may be printed on this machine, as required, from one, two or three double-width (or four-page-wide) rolls of paper. It will also produce magazine forms (with pages half the size of those of the regular issue of the paper) at from 16,000 to 24,000 an hour, either 16, 20, 24, 28, 32, 40 or 48 pages, delivered folded,

## COLLIER'S WEEKLY PRESS

cut, and automatically wire-stitched, with all the pages printed in colors or half-tones.

Such a development of the art of printing, especially in colors, in which accurate register is not only necessary, but must be maintained, would have seemed incredible a few years ago, but this is now a daily occurrence and many newspaper offices produce colored supplements in the same manner and with the same results, having additions placed upon their quadruple, sextuple and other presses for the purpose.

Nor has this development of colors been confined entirely to the demands of the newspaper world. It is gradually finding its way into the weekly periodical and the monthly magazines. It had been considered impossible to print half-tone illustrations on both sides of the sheet at one operation and deliver them flat, without smutting. Not only has this difficulty been overcome, but in the latest presses, such as used by Collier's Weekly, the finest half-tone work is done on a perfecting press printing on a roll of paper. The periodical is printed in multiple pages, as required, and delivered from the machine folded, cut apart and pasted, ready for the binder. It is not desirable, of course, when using fine inks, to make immediate delivery from the press; therefore the papers, after having been perfected, folded and pasted, are left to stand for some hours before they are distributed to the readers. Satisfactory methods of doing this have also been devised. The capacity for printing fine half-tone illustrations on a rotary press having thus been demonstrated the next step is evidently the production of colored half-tones, and the time is undoubtedly near at hand when the monthly magazine as well as the weekly periodical will appear, instead of in black half-tones, now so popular, with these same illustrations printed in the most delicate manner in colors and all delivered in perfection from rotary presses, folded in entirety, or in signatures, ready for the binder.

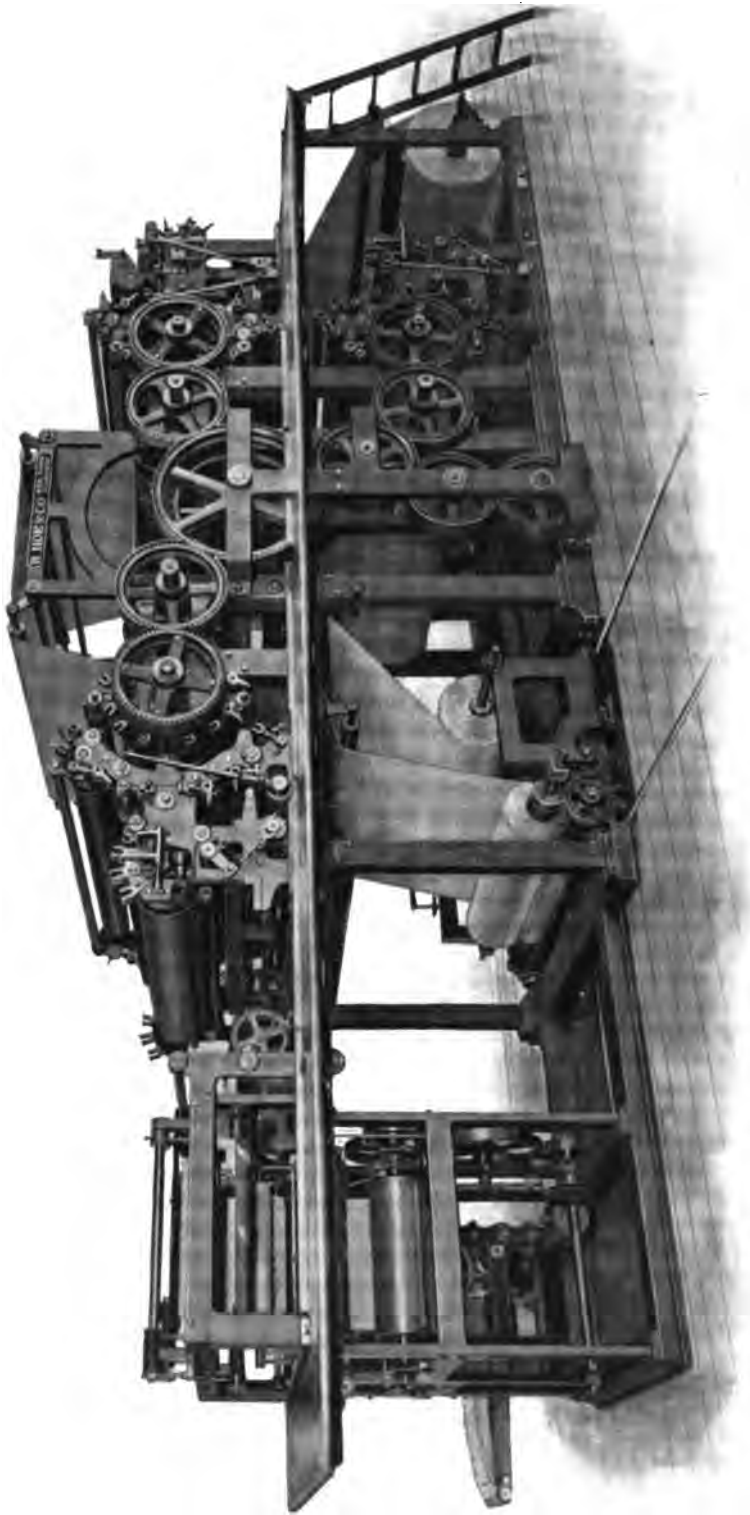

“COLLIER’S WEEKLY” PRESS





## THE PRINTING PRESS

It must now be evident to every experienced observer that the time has arrived when printing upon the rotary system will in a large measure supersede that now done upon flat-bed cylinder presses, although the latter will always be retained for some kinds of work. Satisfactory methods will be devised for attaching upon the cylinders electrotype or stereotype plates of varying sizes. In addition to this, new and improved methods are constantly being brought forward for the transferring of type forms, photographs and illustrations of every description, upon prepared sheets of metal, which receive the ink and give impressions either from a raised surface, as in the ordinary letter-press printing, or in the manner of lithographic printing. These and other new methods of making plates will undoubtedly lead in the future to great economy, as well as to important improvements in the process of printing.

ROBERT HOE.







FROM MEDAL BY SCHARFF





3 2044 024 212 698

THE BORROWER WILL BE CHARGED AN OVERDUE FEE IF THIS BOOK IS NOT RETURNED TO THE LIBRARY ON OR BEFORE THE LAST DATE STAMPED BELOW. NON-RECEIPT OF OVERDUE NOTICES DOES NOT EXEMPT THE BORROWER FROM OVERDUE FEES.

CANCELLED  
JUL 18 1994  
DWP  
713  
WIDENER  
JUN 23 1994  
BOOK DUE  
CANCELLED  
WIDENER  
AUG 3 0  
BOOK DUE

